



Owner's Manual | Guide de l'utilisateur



ALERT

Your new spa's GFCI will trip.

A Ground Fault Interrupter (GFCI) Trip Test must occur to allow proper spa function.

Your spa came with special instructions for the installer / electrician. If they have not already advised you on what to do or expect from the GFCI Trip Test, please contact them for additional information.

If the GFCI breaker connected to your spa trips, this is normal behavior. Please reset the breaker and enjoy your spa. The trip test has been completed successfully.

If your spa is not wired to a GFCI breaker or if your breaker fails the GFCI Trip Test, "GFI" (gFI) will display on the spa panel and the spa will be non operational until the breaker is manually reset. The spa will repeatedly attempt (at preset intervals) to trip the breaker until such time that it triggers a GFCI Trip.

GFCI breakers are important safety devices required by code for your Hot Tub. For more information, refer to your dealer or to the section in your Owner's Manual titled "Ground Fault Circuit Interrupter."

IMPORTANT SAFETY WARNINGS

ENGLISH

FRANÇAIS

SAVE THESE INSTRUCTIONS.

WARNING:

Children should not use spas or hot tubs without adult supervision.

WARNING:

Do not use spas or hot tubs unless all suction guards are installed to prevent body and hair entrapment.

WARNING:

People using medications and/or having an adverse medical history should consult a physician before using a spa or hot tub.

WARNING:

People with infectious diseases should not use a spa or hot tub.

WARNING:

To avoid injury, exercise care when entering or exiting the spa or hot tub.

WARNING:

Do not use drugs or alcohol before or during the use of a spa or hot tub to avoid unconsciousness and possible drowning.

WARNING:

Pregnant, or possibly pregnant, women should consult a physician before using a spa or hot tub.

WARNING:

Water temperature in excess of 104° F or 38° C may be injurious to your health.

WARNING:

Before entering the spa or hot tub measure the water temperature with an accurate thermometer.

WARNING:

Do not use a spa or hot tub immediately following strenuous exercise.

WARNING:

Prolonged immersion in a spa or hot tub may be injurious to your health.

WARNING:

Do not permit electric appliances (such as a light, telephone, radio, or television) within 1.5m of the spa or hot tub.

WARNING:

Maintain water chemistry in accordance with manufacturer's instruction.

WARNING:

The use of alcohol or drugs can greatly increase the risk of fatal hyperthermia in hot tubs and spas.

TABLE OF CONTENTS

GFCI Alert	1	Jet Operation	18
Important Safety Warnings	2	Standard/Economy/Sleep Modes	19
		Filtration Cycles	19
Table of Contents	3	Preset Filter Cycles	19
		Changing Filter Cycle Duration	19
Important Safety Instructions	5	Light	20
Do's and Don'ts	6	Panel Messages	43
Hyperthermia	7	Troubleshooting	43
		Ozone Operation	37
Spa installation	8	Entertainment System (Optional)	34
Site and Positioning	8		
Outdoor Installation	8	Powerworks® 460 Control System	21
Indoor Installation	8	Powerworks® 760 Control System	22
Water Capacity	8	User's Pads	23
		Temperature Controls	23
Spa System Components	10	Jet Operation	23
		Temperature Lock	24
Spa Components	11	Temperature Unlock	24
		Panel Lock	24
Jets, Air Controls & Valves	12	Panel Unlock	24
Jets	12	Light	24
Cleaning or Replacing Jets	12	Standard/Economy/Sleep Modes	24
Air Controls	13	Changing Modes	25
On / Off - Diverter Valve	13	Setting the Time	25
Cleaning or Replacing Valves	13	Preset Filter Cycles	25
		Changing Filter Cycle	26
Electrical Information	14	Clean Up Cycle	26
Important Safety Instructions	14	Inversion Features	27
Ground Fault Circuit Interrupter	14	Ozone Operation	37
Installation Options	14	Entertainment System (Optional)	34
Start Up Procedures	16	Powerworks® 504 Control System	28
Priming Your Spa	16	User's Pads	29
Pr Message	16	Temperature	29
		Jet Operation	29
Powerworks® 167 Control System	17	Light	30
Operating Instructions	17	Operating Modes	30
User's Pads	18	Standard/Economy/Sleep Modes	30
Temperature Controls	18	Preset Filter Cycles	30

Changing Filter Cycles	31	Light Bulbs	41
Clean Up Cycle	31	Spa Cover Care	41
Automatic time Outs	31	Thermal Creep	42
Options and Features	32	Panel Messages	43
AquaBurst Lighting System	32	Common Water Problems	47
Blower / Champagne Air System	32	Common Hardware Problems	50
VitaRoma Aromatherapy System	32	Spa Soaking Guidelines	52
Circulation (Circ) Pump	33	167 Series System Wiring Diagram	53
Inversion Feature	33	460 Series System Wiring Diagram	54
Entertainment System	34	504 Series System Wiring Diagram	55
Therapy Sequencer Control	35	760 Series System Wiring Diagram	56
Therapy Sequencer Program Chart	35		
Starting the Sequencer	36	Safety sign	57
Sequencing Programs	36		
Sequencing Speeds	36	Limited warranty summary	57
Sequencer Pausing	36		
SequencerUser Pad	36	Copyrights and trademarks	58
Safety Features		Notes	59
Automatic Time Outs (165 & 167)	20		
Automatic Time Outs (460 &760)	34		
Automatic Time Outs (504)	33		
Common LCD Messages (165 &167)	43		
Common LCD Messages (460, 504, 760)	43		
Maintenance	37		
Water Chemistry	37		
Sanitizing	37		
pH Level	37		
Sanitizing With Ozone	37		
Specialty Chemicals	38		
Draining Your Spa	38		
Filter Maintenance	39		
Winterizing	39		
Spa Cabinet Care	41		
Spa Surface Care and Cleaning	41		

IMPORTANT SAFETY INSTRUCTIONS

1. READ AND FOLLOW ALL INSTRUCTIONS

- WARNING** - To reduce the risk of injury, do not permit children to use this product unless they are closely supervised at all times.
- A wire connector is provided on this unit to connect a minimum 6 AWG (5.15 mm²) solid copper conductor between this unit and any metal equipment, metal enclosures of electrical equipment, metal water pipe, or conduit within 5 feet (1.5m) of the unit.
- (For cord-connected/convertible units)
DANGER - Risk of injury.
 - Replace damaged cord immediately.
 - Do not bury cord.
 - Connect to a grounded, ground-type receptacle only.
- DANGER** - Risk of Accidental Drowning. Extreme caution must be exercised to prevent unauthorized access by children. To avoid accidents, ensure that children cannot use this spa unless they are supervised at all times.
- DANGER** - Risk of injury. The suction fittings in this spa are sized to match the specific water flow created by the pump. Should the need arise to replace the suction fittings or the pump, be sure that the flow rates are compatible.

Never operate spa if the suction fittings

are broken or missing. Never replace a suction fitting with one rated less than the flow rate marked on the original suction fitting.

- DANGER** - Risk of Electric Shock. Install at least 5 feet (1.5m) from all metal surfaces. As an alternative, a spa may be installed within 5 feet of metal surfaces if each metal surface is permanently connected by a minimum 6 AWG (5.15 mm²) solid copper conductor to the wire connector on the terminal box that is provided for this purpose.
- DANGER** - Risk of Electric Shock. Do not permit any electric appliance, such as a light, telephone, radio, or television, within 5 feet (1.5m) of a spa.
- WARNING** - To reduce the risk of injury:
 - The water in a spa should never exceed 40°C (104°F). Water temperatures between 38°C (100°F) and 104°F (40°C) are considered safe for a healthy adult. Lower water temperatures are recommended for young children and when spa use exceeds 10 minutes.
 - Since excessive water temperatures have a high potential for causing fetal damage during the early months of pregnancy, pregnant or possibly pregnant women should limit spa water temperatures to 38°C (100°F).
 - Before entering a spa the user should measure the water temperature since the tolerance of water temperature-regulating devices varies.
 - The use of alcohol, drugs, or medica-

tion before or during spa use may lead to unconsciousness with the possibility of drowning.

e. Obese persons and persons with a history of heart disease, low or high blood pressure, circulatory system problems, or diabetes should consult a physician before using a spa.

10. **SAVE THESE INSTRUCTIONS**

NOTE: Check with your state/local code enforcement officer to determine electrical code requirements and compliance. Use a qualified licensed electrician to complete all spa final electric connections.

**Caution: Risk of electrical shock.
Read and follow all instructions.**

TO AVOID RISK OF ELECTRICAL SHOCK:

1. A green colored terminal or a terminal marked G, GR, Ground, Grounding, or the international symbol  is located on the side of the supply terminal box or compartment. This terminal must be connected to the grounding means provided in the electric supply service panel, using a continuous copper wire equivalent in size to the circuit conductors supplying this equipment.
**IEC Publication 417, Symbol 5019.*
2. At least two lugs marked "BONDING LUGS" are provided on the external surface or on the inside of the supply terminal box or compartment. Connect the local common bonding grid (house-hold ground) in the area of the hot tub or spa to these terminals, using an insulated or bare copper conductor not smaller than No. 6 AWG.
3. All field-installed metal components such as rails, ladders, drains or similar hardware located within 5 ft. of the spa or hot tub shall be bonded to the equipment grounding bus with copper conductors not smaller than No. 6 AWG.
4. **Never** connect unit to a power supply with a load controller.
5. Install to provide drainage of compartment for electrical components.
6. The electrical supply for this product must include a suitably rated switch or circuit breaker to open all ungrounded supply conductors. This disconnecting means must be readily accessible for operation but installed at least 1.5m from the spa. All electrical connections should comply with local regulations.

Do's and Don'ts

For years of spa enjoyment:

Do:

- **Save these instructions!**
- Replace the cover immediately after use.
- Keep the cover locked when spa is not in use.
- Be aware of the dangers of a wet and slippery surface. Use caution when entering and exiting your spa.
- Have a licensed electrician make all final electrical connections.
- Replace worn, frayed or broken electrical cords.
- Keep the water chemistry correctly balanced. Untreated spa water will cause problems with your spa and equipment as well as being a health risk.
- Clean the spa filter monthly or as needed.
- Position the spa so that all sides remain

accessible for maintenance.

- Use a bathing cap for long hair.
- Refer to information on hyperthermia, next page.
- Use only authorized spa care products for the best performance and to keep the water properly balanced.

Don't:

- Use the spa at 104°F (40°C) for long periods of time (more than 30 minutes).
See Hyperthermia, below.
- Use an extension cord to power your spa.
- Allow anyone to stand on the spa cover. It is not designed to support weight.
- Power the spa unless it is filled with water to 1/8" below the top of the Weir door.
- Operate the pump on high speed for extended periods of time with the cover in place. Extended operation can cause heat build-up and interfere with spa operation.

Hyperthermia

The causes, symptoms, and effects of hyperthermia may be described as follows:

Hyperthermia occurs when the internal temperature of the body reaches a level several degrees above the normal body temperature of 98.6°F (37°C). The symptoms of hyperthermia include an increase in the internal temperature of the body, dizziness, lethargy, drowsiness, and fainting. The effects of hyperthermia include:

- a. Failure to perceive heat
- b. Failure to recognize the need to exit spa or hot tub
- c. Unawareness of impending hazard
- d. Fetal damage in pregnant women
- e. Physical inability to exit the spa or hot tub, and
- f. Unconsciousness resulting in the danger of drowning.

WARNING - The use of alcohol, drugs, or medication can greatly increase the risk of fatal hyperthermia.

SPA INSTALLATION

ENGLISH

FRANÇAIS

Danger: Electrical shock risk. Install at least 1.5m from all metal surfaces.

The electrical supply for this product must include a suitably rated switch or circuit breaker to open all ungrounded supply conductors to comply with Section 422-20 of the National Electrical Code ANSI/NFPA70-1987. The disconnecting means must be readily accessible but installed at least 5 feet (1,5 meters) from the spa water. All electrical connections should comply with article 680-D of the NEC.

Site and Positioning

Locate the spa on solid, level foundation or flooring, keeping in mind the weight of the filled spa [in excess of 4,000 bls. (1.800 kg.) on some models]. If you have any doubts about the load bearing ability of your chosen site, contact an architect or a building contractor.

The entire perimeter of the spa cabinet and the spa bottom must be evenly supported. If your spa is installed outdoors, we recommend that you provide a concrete pad for the spa to rest on 8ft x 8ft x 4in (2,5m x 2,5m x 10cm level pad). **Failure to provide a flat level surface could structurally damage your spa and void the warranty.**

The spa must be installed to allow access for service and maintenance on all four sides; therefore, below grade level installation is not recommended.

Outdoor Installation

The following considerations apply when installing your spa outdoors:

1. Local codes pertaining to fencing.

2. Local electrical and plumbing codes.
3. View from your house.
4. Wind direction.
5. Exposure to sunlight.
6. Location relationship to trees (twigs, leaves and shade).
7. Dressing and bathroom location.
8. Storage area for maintenance equipment and chemicals.
9. Location to facilitate adult supervision.
10. Landscaping and nighttime lighting.
11. Accessibility to equipment.
12. Power supply location and foot traffic.

Indoor Installation

The following considerations apply when installing your spa indoors:

1. Indoor spas promote high humidity. Using either ventilation fans or commercial grade de-humidifiers will help to reduce the humidity. Consult your dealer for details.
2. **Floor drains must be provided near the spa to drain off water that may cause falls and /or water damage.**
3. Floor area should be flat with a non-skid finish. Carpeting is not recommended.
4. Walls, ceilings, woodwork should be made of materials capable of withstanding high humidity (redwood, cedar).
5. Be sure floor load bearing capacities are adequate to support the concentrated spa weight.
6. Spas should be double checked for leaks before installing to avoid possible water damage. Dealer installation may include this service.
7. Indoor sun rooms are capable of maintaining high ambient temperatures

which may effect the spa water temperature. It is NOT recommended that you operate your filter cycles for longer than 4 hours per day under these conditions.

SEE THERMAL CREEP: page 47

MODEL	GALLONS	LITERS
JOLIE	260	985
CABARET	470	1,781
NUAGE	465	1,762
PASSION	130	492
PROTÉGÉ	365	1,382
CHATEAU	360	1,360
RENDEZVOUS	510	1,933
MYSTIQUE	545	2,063
AMOUR	130	493
IMAGE	280	1058
INTRIGUE	375	1417
ELEGANT	375	1417
MONARQUE	350	1323
PRSTIGE	350	1323
ENVY	500	1323
GRAND	550	2079
DUTET	140	530

SPA SYSTEM COMPONENTS

ENGLISH

FRANÇAIS

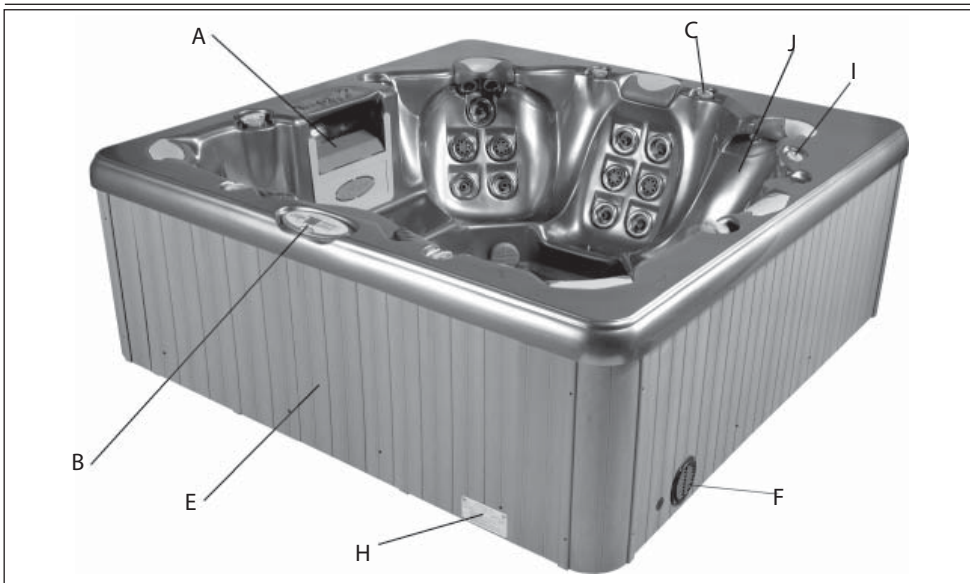

- A. Filter Skimmer/Weir Door:** Removes floating debris from the water surface, provides a water return path to equipment, and houses water filter element.
- B. Topside Control Panel:** Used to control temperature setting, pump for jets, and light.
- C. Air Controls:** Increases or decreases air entering the jets. Close during heating for maximum efficiency.
- D. Wave Seat :** Ultimate relaxation seat.
- E. Equipment Pack Service Panel (no user serviceable parts):** Spa support system consisting of pump(s), heater, optional blower and associated electrical controls (not shown).
- F. Drain Access:** (Adjacent to the equipment service panel) Spa drain faucets.
- G. AquaBurst Lighting:** Lighting system that displays multiple colored lights in pre-programmed random, solid or alternating colours (not shown).
- H. Manufacturer's Identification Label:** Contains identification information for warranty service (serial number, model number, etc.) and electrical information (ampere rating and ampere requirements).
- I. Stereo/Speakers** (not shown).
- J. Sequencer Controls** (not shown).

SPA COMPONENTS

Reference only. Equipment is not always as shown

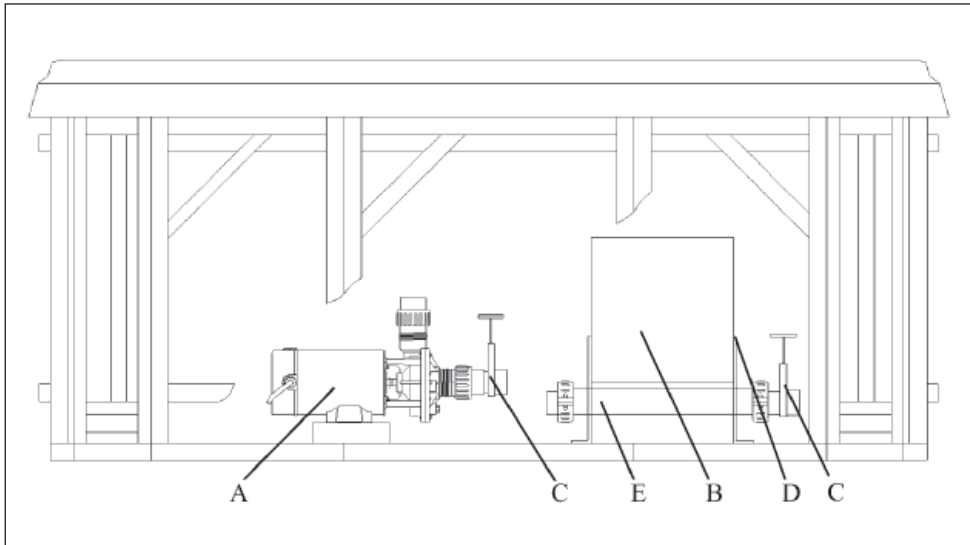

A. Pumps (one or more pumps, depending on model): Low speed for efficient water circulation during filtration and heating; high speed for maximum action of the jets. The pump functions are activated by topside controls. Circ Pump – Continuous Filtration – See Circ Pump details on pg 38

B. Warning and Installation Label: Contains important safety information and installation instructions.

C. Slice Valve: Used to shut off water flow from the spa to the equipment while servicing. Quantity will vary depending on model. All should be open during normal operations.

D. Spa Pack: Houses the electronic circuit board. All equipment and incoming power connections are made here .

E. Heater Assembly: Thermostatically controlled and equipped with an overheat safety shut-off.

Note: No consumer serviceable parts. Do NOT attempt to service any of these components yourself. Contact your dealer for assistance.

JETS, AIR CONTROLS & VALVES

Jets

All spa jets are individually engineered to provide a unique hydro-massage. Depending on the model, your spa will have a combination of the following jets:

Directional Therapeutic (200, 300, and 400 Series Wave Style): Positioned to focus on large muscle groups, these jets deliver a concentrated, high volume stream of water for a deep massage. Each jet is fully adjustable, allowing users to set the water flow to the most comfortable setting. The nozzle can be rotated to target sore muscle areas.

Rotational or Spinning Jets (200, 300, and 400 Series Wave Style): Positioned to focus on muscle tension zones, these jets deliver a spinning water stream for a gentle, pulsating massage. Each jet is fully adjustable, allowing users to set the water flow to the most comfortable setting.

Whirlpool: Positioned to create overall water circulation, this multi-purpose, high volume jet provides whirlpool action throughout the entire spa.

Euro Jets: Positioned in the foot well or shoulder areas of the spa, these jets deliver a penetrating massage to dissolve tension. This jet may be the entry point for ozone produced during the automatic filtration cycles, and, as such, is not adjustable.

Note: Ozone production is suspended when other functions are activated on the control panel by the spa user.

NOTE: In spas equipped with a circ pump the ozonator can not be shut off and will remain on as long as the circ pump is running.

All full sized jets are adjustable from a fully open to closed position. It is very important that you **NEVER SHUT ALL FULL SIZED JETS OFF AT ONE TIME!** WHEN EXITING THE SPA, OPEN ALL CLOSED JETS.

Cleaning or Replacing Jets

Hard water can cause calcium/mineral buildup that can restrict or bind the jets. A jet consists of a face plate and a nozzle. Rotate these parts weekly and remove/clean monthly to ensure free movement.

NOTE: It is not necessary to drain the spa to clean or remove the jets.

Rotating the jet face plate and nozzle

- Rotate the jet face left and right (open and closed).
- Return the face plate to the full open position.
- Turn the jets on to high speed.
- Twist the nozzle left and right.
- Rotate the nozzle in the socket.

NOTE: If the jet insert disengages from the spa housing, see steps to reinstall below.

Cleaning the jets

To **remove** the jet insert, use the palm of your hand to exert pressure on the face of the jet. Turn counterclockwise until the jet 'clicks'. Gently pull the jet assembly from the housing.

To **clean** the jet insert and housing, use a pressurized hose and spray the inside of the jet housing. Soak the jet in a diluted spa cleaning solution, rinse. Wipe the inside of the housing to remove any debris.

To **reinstall** the jet, line up the tab on the backside of the barrel with the groove in the body. Use the palm of your hand to gently tab the jet until it snaps into position.

Air Controls

The intensity of the jet action can be controlled by altering the amount of air injected with water through the jets. Your spa has 2 to 4 air controls located on the lip of the spa. Each control activates air to specific jets in the spa allowing you to create various combinations and levels of jet action to suit individual preferences. Turn the control counter- clockwise to turn the air off and clockwise to turn air on.

NOTE: Air controls should be closed during heating cycles for maximum energy efficiency.

NOTE: At the start of a filtration cycle, the Champagne Air System is activated to purge the lines and ensure complete filtration. Ensure that at least one air control is always fully open.

On / Off Valve: Turns on or shuts off the flow of water to multiple jets or the waterfall.

Diverter Valve: Diverts water from one set of jets to another.

NOTE: The diverter and on / off valve(s) should be cleaned regularly. Remove the handle by pulling upward and rocking it back and forth, unscrew the cap and pull the valve stem out. To **clean** the valve stem and housing, use a pressurized hose and spray the inside of the valve housing. Soak the valve stem in a diluted spa cleaning solution, rinse. Wipe the inside of the housing to remove any debris.

ELECTRICAL INFORMATION

ENGLISH

FRANCAIS

Caution: Risk of electrical shock.
Read and follow all instructions.

Important Safety Instructions

All electrical connections to this spa package MUST be accomplished by a qualified licensed electrician in accordance with National Electrical Code (NEC) and with state/local electrical codes in effect at the time of installation.

NOTE: Prior to performing any service to the spa equipment, turn OFF all primary electrical power at the main circuit breaker or disconnect panel.

To make spa electrical connections, remove the exterior equipment pack service panel, locate the electrical control box, remove the control box cover and follow the wiring diagram on the inside of the control box cover. Connections should be made using copper conductors **only**. Connecting wires, circuit breakers, or fuses must all be sized to accommodate the Total Ampere load as specified on the equipment label. This equipment is designed to operate on 60Hz alternating current only, at 240 volts.

NOTE: All unions must be hand-tight and all slice valves must be locked in the OPEN position before filling or refilling spa! A clip is provided to help keep the slice valve open. Run spa and check for union water leaks before reinstalling exterior panel.

Ground-Fault Circuit Interrupter

A qualified licensed electrician shall connect the spa to a circuit protected by a GFCI. This is a requirement by the National Electric Code, article 680-42, and is also in compliance with Underwriter's Laboratories, Inc.

Installation Options

A hole will need to be drilled in the pedestal or base to bring the electrical conduit into the spa cabinet.

Refer to the manufactures's nameplate located on the kick plate to determine your spa's ampere requirements.

240 Volt Installation

Permanently Connected:

The Models Amour, Intrigue & Image (Standard Configuration) come factory set for 240 volt service.

Electrical Requirements:

- **240 volt, 60 Hz, single phase, 40 or 30 amp., 4-wire service (line 1, line 2, neutral, and ground)**
***30 Amp Option**

The heater can only be activated with the pump on low speed. Only the spa light can be operating at the same time without disabling the heater. See your authorized Vita Spa dealer to select this option.

Caution: Risk of electrical shock.
Read and follow all instructions.

240 Volt Installation

Permanently Connected:

The Models Amour, Intrigue, & Image (Blower or Circ Pump Option) come factory set for 240 volt service.

Electrical Requirements:

- **240 volt, 60 Hz, single phase, 50 or 40 amp., 4-wire service (line 1, line 2, neutral, and ground)**
*40 Amp Option

The heater can only be activated with the pump on low speed. Only the spa light can be operating at the same time without disabling the heater. See your authorized Vita Spa dealer to select this option.

240 Volt Installation

Permanently Connected:

The Models Envy, Grand, Joli, Cabaret, Rendezvous, Monarque, Mystique, Prestige, Elegant, Passion, Chateau, & Nuage come factory set for 240 volt service.

Electrical Requirements:

- **240 volt, 60 Hz, single phase, 60 or 40 amp., 4-wire service (line 1, line 2, neutral, and ground)**
*40 Amp Option

The heater can only be activated only with the pump on low speed. Only the spa light. can be operating at the same time without disabling the heater. See your authorized Vita Spa dealer to select this option.

Important Safety Instructions

All electrical connections to this spa package MUST be accomplished by a qualified licensed electrician in accordance with National Electrical Code (NEC) and with state/

local electrical codes in effect at the time of installation.

NOTE: Prior to performing any service to the spa equipment, turn OFF all primary electrical power at the main circuit breaker or disconnect panel.

Spas installed for 240 volt, 60 Hz, single phase operation require a 4-wire, 30, 40, 50 or 60 amp., 240 volt sub-feed in non-metallic pipe to the spa equipment compartment (line 1, line 2, neutral and ground). A green colored terminal (or wire connector marked "G", or "GR", or "Grounding") is provided in the control box. To reduce the risk of electrical shock, connect this terminal or connector to the grounding terminal of your electrical service or supply panel with a continuous green insulated copper wire equivalent to the circuit conductor supplying this equipment, but no smaller than No. 12 AWG. A second pressure wire connector is provided on the surface of the control box for bonding to local ground points. To reduce the risk of electrical shock, this connector should be bonded with a No. 6 AWG copper wire to any metal ladders, water pipes, or any metal within 5 feet of the spa.

Note: Copper wire is strongly recommended for all electrical connections.

START UP PROCEDURES

Follow recommendations for site location and electrical connection. The water line on the weir door is the level at which the water should be maintained.

1. Fill the spa through the filter hole to 1/8" below the top of the Weir door. with tap water. **Never use 'softened' water in your spa.** Softened water can impact the chemical balance of the water and lead to degradation of metal plumbing fittings.
2. Turn power on to unit at circuit breaker or disconnect panel.
3. Open the air controls, located on the top lip, and cycle the jets from high to low. Water should come from the therapy jets. If water flow is not established, turn off jets and see Priming Your Spa (this page).
4. Add chemicals. Ask your dealer for additional information on start up or getting the water balanced.

Follow Operating Instructions for your particular model to set heat to the desired temperature. Initially, you may find that the spa requires 12 to 14 hours on 230 Volt installations to reach temperature. Keep your thermal cover on the unit and close the air controls to help the heating process.

NOTE: At the start of a filtration cycle, the Air System is activated to purge the lines and ensure complete filtration. If you have the air system nsure that at least one air control is always fully open.

Important: Do not operate the spa without full water flow.

Priming Your Spa

When filling your spa for the first time or, after draining and refilling the spa, you may need to bleed air from the system. Should you experience an air-lock on Pump 1, remove the filter cover, insert a garden hose through each center hole that holds the filter as far as possible without using force. Hold the hose in place and turn on the water. Cycle pump 1 from low to high several times, this forces water into the pump and forces the air out. If this does not work or you experience an air-lock on Pump 2, remove the side panel and locate the pump. With the pump on high speed, slowly loosen the discharge (top) pump union until water starts to trickle out. Once water is trickling out, hand tighten the union (do not over tighten as this could cause the union to crack) and replace the side panel

Pr - This is Not an Error Message

The Spa has just been powered up and is in Priming Mode for 4 Minutes. Pumps can be turned ON and OFF to remove any air from the plumbing lines and the Heater. Cycle the pumps on and off to verify good water flow and wait 4 minutes or press any temp related button to exit Priming Mode.

POWERWORKS® 167 CONTROL SYSTEM

Amour, Image, & Intrigue

ENGLISH
FRANÇAIS



If your Topside Control looks like this, your spa has the following features:

- Internal Light
- 1 Dual Speed Pump



If your Topside Control looks like this, your spa has the following features:

- Internal Light
- 1 Dual Speed Pump
- Champagne Air System

The 167 Series Powerworks™ Controls offer you the ultimate in spa control. The backlit, Liquid Crystal Display (LCD) displays current temperature, set water temperature, and operating mode settings. Each feature is actuated through the control panel pad. Touch the appropriate button to activate the desired function.





NOTE: The CIRC PUMP option will change the operation of the factory default settings and modes of operation of your spa. All filtration and heating is now controlled by the CIRC PUMP. If your spa has a CIRC PUMP see specific CIRC PUMP information on page 33

VITA SPA

At start up, when power is supplied to the spa, the controls will operate properly and safely under the factory settings. The spa will be in **Standard** mode, have a temperature setting of 100°F (38°C), and a filtration cycle duration of 2 hours. To fully utilize the unique capabilities of the control system, it is important to know how to set the temperature, operate the pumps, operate the light, adjust the mode setting, and change the filtration cycle.

User's Pads

User's Pads are the buttons located on the topside control panel and are used to program various spa functions (i.e., turn on spa light, set temperature, etc.). The following table defines the buttons:

Pad	Use
 Temp	<ul style="list-style-type: none"> • Decrease temperature • Increase temperature • Switch modes • Change filter cycle durations
 Lght	<ul style="list-style-type: none"> • Turn internal spa light on or off • Switch modes
 Jets	<ul style="list-style-type: none"> • Activate therapy pump • Set duration of filter cycles
 Blower	<ul style="list-style-type: none"> • Activate Champagne Air System

Temperature

The maximum set temperature is 104°F (40°C) and the minimum set temperature is 80°F (26°C). The current water temperature or, if the pump has not been running, two dashes, will show on the display. If dashes are displayed, you must first start the pump by pressing the **PUMP 1** pad. Wait until the water temperature is displayed (approximately 2 minutes).

The set temperature of your spa may easily be increased or decreased at any time using the **'TEMP'** pad. Press the **'TEMP'** pad; the set temperature will be displayed in the LCD window. The next touch of **'TEMP'** will change the set temperature either up or down 1°F (0,5°C). If you want to increase the temperature and the displayed indicates the temperature was increased by 1°F (0,5°C), continue to press the **'TEMP'** pad until the desired set temperature is reached.

If you want to decrease the set temperature and the LCD indicates that the temperature is increasing, **STOP**. Wait a few seconds until the actual temperature is displayed. Then press the **'TEMP'** pad again. The set temperature will be displayed. Press it again and the set temperature will decrease by 1°F (0,5°C). Continue pressing the **'TEMP'** pad until the desired set temperature is reached.

If the spa is set in Standard mode or in a filtration cycle, increasing the set temperature may result in activating the heater. Decreasing the set temperature will turn the heater off. When the heater is operating, the LCD below the **'HEAT'** icon will be lit.

Pump 1

Touch the **'JETS'** pad to activate the primary filtration pump. The sequence of the jet action is:

- 1 touch = Low therapy jets
- 2 touches = High therapy jets
- 3 touches = Off

The low speed operation of Pump 1 is timed to automatically turn off after two hours of operation. The high speed operation of Pump 1 is timed to automatically turn off after 30 minutes of operation.

NOTE: With the standard configuration, pump 1 will automatically operate in low speed whenever the spa calls for a filtration cycle or heat. When this automatic activation occurs, the low speed of Pump 1 cannot be turned off; however, all other control functions can be activated.

MODES OF OPERATION:

In the standard configuration (NO circ pump option) your spa can be switched among **Standard, Economy, and Sleep modes** by touching the 'TEMP' pad and then the 'LIGHT' pad. If your spa is in the

Standard mode,

the low speed of Pump 1 and the heater will come on automatically to maintain the set temperature of the water. The pump will circulate for approximately two minutes several times throughout the day to sample water temperature. If your spa is set in the

Economy mode,

the heater will operate **ONLY** during the filtration cycles. If your spa is set in the **Sleep mode,**

The spa will heat to within 20°F (11°C) of the set temperature only during filter cycles.

The pump will operate either during a normal filtration cycle or, the heater and pump will be activated when the heater housing temperature drops below 45°F (7.2°C).

The selected mode will be displayed in the LED window of the control panel.

When in **Standard mode**, the letters 'ST' are displayed briefly, followed by the water temperature. When in **Economy mode**, the letters 'EC' are displayed alternately with the water temperature.

When in **Sleep mode**, the letters 'SL' are displayed alternately with the water temperature.

Setting the Time and Filtration Cycles

You can decide when your filter cycles start and you also have choices on how long they run.

Preset Filter Cycles. The spa control system is designed with two filter cycles. The first filter cycle turns on 6 minutes after power is supplied to the spa. The second filter cycle turns on 12 hours later. Filter cycles are pre-set for a two hour duration.

Note: To properly clean and maintain spa, a total filter time of at least four hours per day is recommended. If an ozonator is installed, 6 hours is recommended.

Changing Filter Cycle Start Time

The start/stop times of the filter cycle begin 6 minutes after the spa set time is established. Set time is based on the time of day that the spa is powered up. Set time may only be changed by disconnecting power from the spa and re-connecting it at the desired start time. For example, if you want the filter cycle to begin at **9:00 PM**, turn off the spa breaker and turn it back on at **8:54 PM** (remember the 6 minute wait period). The cycle will begin at **9:00 PM** and will repeat beginning at **9:00 AM**. Each cycle will run for the prescribed number of hours.

Changing Filter Cycle Duration

The duration of a filter cycle can be set in hour increments of 2, 4, 6, 8, or continuous. For example, a 2 hour cycle will complete once every 12 hours for a total of 4 hours per day. The amount of time needed to filter you spa will depend on usage and ambient conditions. You will need to program you filter cycles based upon your personal use.

To change the duration of the filter cycles

touch the 'TEMP' pad and then touch the 'JETS' pad. Touch the 'TEMP' pad to adjust the cycle duration to the desired setting. After each press, the duration of the cycle will be displayed in the LCD window as follows:

- F2** 2 Hours for each cycle, 4 hours per day
- F4** 4 Hours for each cycle, 8 hours per day
- F6** 6 Hours for each cycle, 12 hours per day
- F8** 8 hours for each cycle, 16 hours per day
- FC** Continuous filtration, 24 hours per day

To exit the filter-set procedure, touch 'JETS'. The LCD window will display the current water temperature.

If a change is made to the duration while the spa is in a filtration cycle, it will take effect immediately. If the change is made outside a filtration cycle, it will take effect at the start of the next scheduled cycle.

NOTE: When power to the spa is denied (disconnect, power outage), the controls may revert to the default factory settings. Any adjustments to set temperature or filter cycle duration may need to be reprogrammed.

Light

Touch the 'LIGHT' pad to turn all lights on and off. The lights will automatically turn off after 4 hours of operation.

Automatic Time Outs

Your Vita Spa is equipped with an automatic Time Out feature designed to protect both the equipment and the user. To reduce unnecessary use of the pumps and lights, the Time Out feature turns selected accessories off automatically.

Accessory	Mode	Shuts off in...
Blower		30 minutes
Pump 1	Low	2 hours
Pump 1	High	30 minutes
Pump 2	High	30 minutes
Circ Pump		Never
Light		4 hours

THERMAL CREEP: see page 46

OZONE OPTION: see page 41

VITAROMA OPTION: see page 36

CIRC PUMP OPTION: see page 37

ENTERTAINMENT SYSTEM OPTION: see page 38

BLOWER / CHAMPAGNE AIR SYSTEM OPTION: see page 36

AQUABURST LIGHTING SYSTEM OPTION: see page 36

POWERWORKS® 460 CONTROL SYSTEM

460 Series Control System for Spa Models Joli, Cabaret, Nuage, Passion, Prestige, Chateau



If your Topside Control looks like this, your spa has the following features:

- Internal Lights
- Blower / Air System
- 2 Pumps



If your Topside Control looks like this, your spa has the following features:

- Internal Lights
- 2 Pumps

The 460 Control System offers you the ultimate in spa control. The backlit, Liquid Crystal Display (LCD) displays current water temperature, set point water temperature, time, and operating mode settings.

Each feature of the system is actuated through a control panel touch pad.

Touch the appropriate pad to activate the desired function.

NOTE: The CIRC PUMP option will change the operation of the factory default settings and modes of operation of your spa. All filtration and heating is now controlled by the CIRC PUMP. If your spa has a CIRC PUMP see specific CIRC PUMP information on page 33.

At start up, when power is supplied to the spa, the controls will operate properly and safely under the factory settings. The spa will be in **Standard Mode**, have a temperature setting of 100°F (38°C), and a filtration cycle duration of 2 hours. To fully utilize the unique capabilities of the control system, it is important to know how to set the temperature, operate the pumps, operate the light, adjust the mode setting, and change the filtration cycles.

Note: In event of a power outage or failure, the 460 Series Control System may retain settings. If settings are lost, re-program per the instructions in this manual.

POWERWORKS® 760 CONTROL SYSTEM

ENGLISH

FRANÇAIS

760 Series Control System for spa models Rendezvus and Mystique



If your Topside Control looks like this, your spa has the following features:

- Internal Lights
- Blower / Champagne Air System
- 2 Dual Speed Pumps



If your Topside Control looks like this, your spa has the following features:

- Internal Lights
- 2 Dual Speed Pumps



If your Topside Control looks like this, your spa has the following feature:

- 1 Additional Single Speed Pump

The Powerworks™ 760 Series Control System offers you the ultimate in spa control. The backlit, Liquid Crystal Display (LCD) displays current water temperature, set point water temperature, time, and operating mode settings. Each feature of the system is actuated through a control panel touch pad. Touch the appropriate pad to activate the desired function.









At start up, when power is supplied to the spa, the controls will operate properly and safely under the factory settings. The spa will be in **Standard** mode, have a temperature setting of

100°F (38°C), and a filtration cycle duration of 2 hours. To fully utilize the unique capabilities of the control system, it is important to know how to set the temperature, operate the pumps, operate the light, adjust the mode setting, and change the filtration cycles.

Note: In event of a power outage or failure, the 760 Series Control System may retain setngs. If settings are lost, re-program per the instructions in this manual.

User's Pads

User's Pads are the buttons located on the topside control panel and are used to program various spa functions (i.e., turn on spa light, set temperature, etc.). The following table defines the pads:

Pad	Use
 UP	<ul style="list-style-type: none"> • Increase temperature • Change time settings • Used in alternate programming sequences
 Down	<ul style="list-style-type: none"> • Decrease temperature • Change time settings • Used in alternate programming sequences
 Time	<ul style="list-style-type: none"> • Used in alternate programming sequences • Exit programming • View the Time
 Prog	<ul style="list-style-type: none"> • Switch modes • Set time and filtration cycles
 Light	<ul style="list-style-type: none"> • Turn all spa light on or off
 Air	<ul style="list-style-type: none"> • Blower / Champagne Air System • To activate the INVERSION feature
 Jets 1	<ul style="list-style-type: none"> • Activate primary filtration pump • Used in alternate programming sequences
 Jets 2	<ul style="list-style-type: none"> • Activate therapy pump

Temperature

The maximum set temperature is 104°F (40°C) and the minimum set temperature is 80°F (26°C). The current water temperature or, if the pump has not been running, two or three dashes, will show on the display. If dashes are displayed, you must first start the pump by pressing the 'JETS 1' pad.

Wait until the water temperature is displayed (approximately 2 minutes).

The set temperature of your spa may easily be increased or decreased at any time using the 'UP' or 'DOWN' pads. When either of these pads is touched, the set temperature will be displayed in the LCD window. Each successive touch will change the set temperature 1°F (0,5°C) in the chosen direction. After 3 seconds the LCD will automatically display the water temperature or dash lines.

If the spa is set in Standard mode or in a filtration cycle, adjusting the set temperature may result in activating the heater.

When the heater is operating, the heat icon will be displayed in the LCD.



JETS 1

Touch the 'JETS 1' pad to activate the primary filtration pump. The sequence of the jet action is:

- 1 touch = Low therapy jets
- 2 touches = High therapy jets
- 3 touches = Off

JETS 2

Touch the 'JETS 2' pad to activate the therapy pump. The sequence of jet action is:

- 1 touch = Low therapy jets
- 2 touches = High therapy jets
- 3 touches = Off

JETS 3

Touch the 'JETS 3' pad to activate the therapy pump in conjunction with the sequencer.

The sequence of jet action is:

- 1 touch = High therapy jets
- 2 touches = Off

The low speed operation of Pump 1 is timed to automatically turn off after two hours of operation. The high speed operation of Pump 1 and Pumps 2 & 3, are timed to automatically turn off after 15 minutes of operation.

The low speed of Pump 1 runs when the blower or any other pump is on. In the STANDARD mode it will also activate for at least 2 minutes every 30 minutes to detect the spa water temperature and then remain on to heat to the set temperature if needed. When this automatic activation occurs, the low speed of Pump 1 cannot be turned off; however, all other control functions can be activated.

Light

Touch the 'LIGHT' pad to turn all lights on and off. The lights will automatically turn off after 4 hours of operation.

Spa Control Locks

The corresponding lights on the spa panel will illuminate to show the spa control locks or filter cycles that are currently active.

Temperature Lock (TL)

Once you have set the desired water temperature, you may lock-in the new setting to prevent unauthorized temperature adjustments to your spa.

To lock the set temperature: Touch 'UP' or 'DOWN', then touch 'TIME', 'JETS 1' and 'UP' within 3 seconds. The 'TL' indicator will light

when the set temperature is locked.

Temperature Unlock

To unlock the temperature, touch either 'UP' or 'DOWN', then touch 'TIME', 'JETS 1', and 'DOWN' within 3 seconds. The 'TL' indicator light will go out when the set temperature lock is cleared.

Panel Lock (PL)

To help prevent unauthorized use of your spa, the control system has a unique panel locking system. To lock the panel, touch 'TIME', 'JETS 1', then 'UP' within 3 seconds. When locked, the 'PL' indicator light will be on. Except for the time button, everything will be frozen. When the control panel lock is engaged, all automatic spa functions will operate normally but cannot be altered.

Panel Unlock

To unlock the panel, touch the 'TIME', 'JETS 1', and 'DOWN' within 3 seconds. The 'PL' indicator light will go out when the panel lock is cleared.

Operating Modes

Your Vita Spa comes with three primary operating modes.

Standard Mode maintains the water at the desired set temperature. Note that the last measured spa temperature displayed is current only when the pump has been running for at least 2 minutes. The 'STD' icon will be briefly displayed in the LCD window when this mode is selected. The word standard will constantly be displayed on the panel

Economy Mode heats the water to the desired set temperature **ONLY** during filter

cycles. The 'ECN' icon may be displayed in the LCD window and the word economy will be displayed on the panel when this mode is selected. While in the Economy mode, pressing the 'JETS 1' button will put the spa into the **Standard-In-Economy** mode, which operates the same as the Standard Mode, then reverts back to the Economy mode after 1 hour. The spa can be immediately reverted back into the Economy mode at any time by simply pressing the 'PROG' button.

Sleep Mode heats the spa to within 20°F (11°C) of the set temperature only during filter cycles. The 'SLP' icon may be displayed in the LCD window and the word sleep will be displayed on the panel when this mode is selected.

Standby Mode: While in this mode, all spa functions are temporarily suspended to allow for filter changes or other routine maintenance tasks.

Changing Modes

To change the operating mode, press the 'PROG' button. The operating mode will be flashing on the LCD window. Press the 'DOWN' button to cycle through to the desired mode, and then press the 'PROG' button to confirm selection. Pressing

Pressing 'UP' or 'DOWN' then 'JETS2' will put the spa into the Standby Mode. Press any button to exit the Standby mode.

Time and Filtration Cycles

The control system on your spa has been designed to function properly and safely at 104F (40°C) after connecting the electrical

wires and installing the proper grounds. To take full advantage of the unique capabilities of your new spa, you should first set the time and establish your filtration cycles.

Setting the Time

When the time of day has not been programmed, the icon will be flashing on the LCD window. To set the time of day, first press the 'TIME' button then press the 'PROG' button. The hour digit(s) will be flashing on the LCD window. Press the 'UP' or 'DOWN' button to advance the hours up or down to the desired set point. Press the 'PROG' button to enter the time hour. The minute digits will now be flashing on the LCD window. Press the 'UP' or 'DOWN' button to advance the minutes up or down to the desired set point. Press the 'PROG' button to enter the time minutes. At this point you can either proceed with setting the filtration cycles as described in the following 'Changing Filter Cycle' section, or press the 'TIME' button to save the settings and exit the programming sequence.

Preset Filter Cycles

Once the time of day has been set, your spa will automatically filter the water for a 2-hour period every 12 hours.

The first filter cycle comes preset to operate from **8:00AM to 10:00AM**, and the second filter cycle comes preset to operate from **8:00PM to 10:00PM**. The F1 indicator light will be lit whenever the spa is in the first filter cycle. The F2 indicator light will be lit whenever the spa is in the second filter cycle. During a filter cycle, the primary filtration pump will operate in low speed and can not be turned off unless the spa is put into the

Standby mode. At the beginning of each filtration cycle, the other equipment in the spa will turn on for 30 seconds to purge all plumbing lines and ensure complete filtration.

Changing Filter Cycles

The control system allows you to adjust the start time and duration of each filter cycle independently to best suit your schedule. The amount of time needed to filter your spa will vary depending upon usage and ambient conditions, but a total filter time of at least four hours per day is recommended to properly clean and maintain the water.

To initiate the programming sequence to change the filter cycles, press 'TIME', 'PROG', 'PROG', and 'PROG' within 3 seconds.

If you are setting the filter cycles as a continuance from setting the time then proceed to the next paragraph.

press 'PROG'

You should now see the 'PROGRAM', 'FILTER 1', and 'START TIME' icons on the LCD display window. The hour digit(s) will be flashing on the LCD window. Press the 'UP' or 'DOWN' button to advance the hours up or down to the desired set point. Press the 'PROG' button to enter the time hour. The minute digits will now be flashing on the LCD window. Press the 'UP' or 'DOWN' button to advance the minutes up or down to the desired set point. Press the 'PROG' button to enter the time minutes.

You should now see the 'PROGRAM', 'FILTER 1', and 'END TIME' icons on the LCD display window. Adjust the hours and minutes for the end time of the first filter cycle as described above.

After pressing the 'PROG' button to enter the end time of the first filter cycle, you should now see the 'PROGRAM', 'FILTER 2', and 'START TIME' icons on the LCD display window. Adjust the hours and minutes for the start time of the second filter cycle as described above.

After pressing the 'PROG' button to enter the start time of the second filter cycle, you should now see the 'PROGRAM', 'FILTER 2', and 'END TIME' icons on the LCD display window. Adjust the hours and minutes for the start time of the second filter cycle as described above.

After pressing the 'PROG' button to enter the end time of the filter cycle, the new filtration times will be saved into the system and the LCD window will revert back to display the current water temperature. Pressing the 'TIME' button at any time during the above programming sequence will save the values entered up to that point and exit the programming sequence. To set the spa for continuous filtration, set the start and end times of the first filter cycle to the exact same time.

Note: To properly clean and maintain spa, a total filter time of at least four hours per day is recommended. If an ozonator is installed, 6 hours is recommended.

Clean Up Cycle

After periods of heavy use, you can manually start a clean-up cycle by turning Pump 1 on in low speed. The pump will operate for 2 hours and then automatically turn off. The heater will also operate during this period if the controls are set in the Standard mode.

NOTE: Activating the low speed of Pump 1 for a clean-up cycle will initiate filtration, but not ozone production, unless the spa

enters a timed filter cycle during the 2 hour period.

Inversion Feature

The Control System includes an Inversion feature that makes it easy to read the LCD from inside or outside the spa. To invert the LCD display, touch the 'UP' or 'DOWN' button, followed by the 'AIR' button. Repeat the sequence to reverse the inversion process.

If your spa is not equipped with the optional Champagne Air feature, locate the position of the AIR button (next to the LIGHT button) and press in that general location

Automatic Time Outs

Your Vita Spa is equipped with an automatic Time Out feature designed to protect both the equipment and the user. To reduce unnecessary use of the pumps and lights, the Time Out feature turns selected accessories off automatically.

Accessory	Mode	Shuts off in...
Blower		15 minutes
Pump 1	Low	2 hours
Pump 1	High	15 minutes
Pump 2	Lo / Hi	15 minutes
Pump 3	High	15 minutes
Circ Pump		Never
Light		1 hour

THERMAL CREEP: see page 46

OZONE OPTION: see page 41

VITAROMA OPTION: see page 36

CIRC PUMP OPTION: see page 37

ENTERTAINMENT SYSTEM OPTION: see page 38

Blower / Champagne Air System OPTION: see page 36

DIGITAL OPTIC LIGHTS see page 36

THERAPY SEQUANCER : see page 39

POWERWORKS® 504 CONTROL SYSTEM

ENGLISH

FRANÇAIS

Intrigue, Elegant, Monarque, Prestige, Envy, & Grand



If your Topside Control looks like this, your spa has the following features:

- Internal Lights
- Blower / Champagne Air System
- 1 Dual Speed Pump
- 1 Single Speed Pump



If your Topside Control looks like this, your spa has the following features:

- Internal Lights
- 1 Dual Speed Pump
- 1 Single Speed Pump

The Powerworks™ 504 Series Control System offers you the ultimate in spa control. The backlit, Liquid Crystal Display (LCD) displays current water temperature, set point water temperature and operating mode settings. Each feature of the system is actuated through a control panel touch pad. Touch the appropriate pad to activate the desired function.







At start up, when power is supplied to the spa, the controls will operate properly and safely under the factory settings. The spa will be in **Standard** mode, have a temperature setting of

100°F (38°C), and a filtration cycle duration of 2 hours. To fully utilize the unique capabilities of the control system, it is important to know how to set the temperature, operate the pumps, operate the light, adjust the mode setting, and change the filtration cycles.

Note: In event of a power outage or failure, the 504 Series Control System may retain settings. If settings are lost, re-program per the instructions in this manual.

User's Pads

User's Pads are the buttons located on the topside control panel and are used to program various spa functions (i.e., turn on spa light, set temperature, etc.). The following table defines the pads:

Pad	Use
 Up	<ul style="list-style-type: none"> • Increase temperature • Change time settings • Used in alternate programming sequences
 Down	<ul style="list-style-type: none"> • Decrease temperature • Change time settings • Used in alternate programming sequences
 Prog	<ul style="list-style-type: none"> • Switch modes
 Light	<ul style="list-style-type: none"> • Turn internal spa light on or off
 Air	<ul style="list-style-type: none"> • Blower / Champagne Air System
 Jets 1	<ul style="list-style-type: none"> • Activate primary filtration pump • Used in alternate programming sequences
 Jets 2	<ul style="list-style-type: none"> • Activate therapy pump

Temperature

The maximum set temperature is 104°F (40°C) and the minimum set temperature is 80°F (26°C). The current water temperature or, if the pump has not been running, two dashes, will show on the display. If dashes are displayed, you must first start the pump by pressing the 'JETS 1' pad. Wait until the water temperature is displayed (approximately 2 minutes).

The set temperature of your spa may easily be increased or decreased at any time using the 'UP' or 'DOWN' pads. When either of these pads is touched, the set temperature will be displayed in the LCD window. Each successive touch will change the set temperature 1°F (0.5°C) in the chosen direction. After 3 seconds the LCD will automatically display the water temperature or dash lines.

If the spa is set in Standard mode or in a filtration cycle, adjusting the set temperature may result in activating the heater. When the heater is operating, the heat icon will be displayed in the LCD.

Note: 230-Volt spas that are wired with the low Amp option will not heat when Pump 1 is on in high speed, or when Pump 2 is in operation.

JETS 1

Touch the 'JETS 1' pad to activate the primary filtration pump. The sequence of the jet action is:

- 1 touch = Low jets
- 2 touches = High jets
- 3 touches = Off

JETS 2

Touch the 'JETS 2' pad to activate the therapy pump. The sequence of jet action is:

- 1 touch = High jets
- 2 touches = Off

The low speed operation of Pump 1 is timed to automatically turn off after 4 hours of operation. The high speed operation of Pump 1 and the high speed operation of Pump 2, are timed to automatically turn off after 15 minutes of operation.

NOTE (NON-Circ Pump Systems): The low speed of Pump 1 runs when the blower or any other pump is on. In the STANDARD mode it will also activate for at least 2 minutes every 30 minutes to detect the spa water temperature and then remain on to heat to the set temperature if needed. When this automatic activation occurs, the low speed of Pump 1 cannot be turned off; however, all other control functions can be activated.

Light

Touch the 'LIGHT' pad to turn all lights on and off. The lights will automatically turn off after 4 hours of operation.

Operating Modes

Your Vita Spa comes with three primary operating modes.

Standard Mode maintains the water at the desired set temperature. Note that the last measured spa temperature displayed is current only when the pump has been running for at least 2 minutes. The 'STD' icon will be briefly displayed in the LCD window when this mode is selected.

Economy Mode heats the water to the desired set temperature **ONLY** during filter cycles. The 'ECN' icon will be displayed in the LCD window when this mode is selected.

Sleep Mode heats the spa to within 20°F (-6.6°C) of the set temperature only during filter cycles. The 'SLP' icon will be displayed in the LCD window when this mode is selected.

Changing Modes

To change the operating mode, press the 'UP' or 'DOWN' and then press the 'PROG' button. The operating mode will be flashing on the LCD window. Press the 'DOWN' button to cycle through to the desired mode.

Time and Filtration Cycles

The control system on your spa has been designed to function properly and safely at 100°F (38°C) after connecting the electrical wires and installing the proper grounds. To take full advantage of the unique capabilities of your new spa, you should first set the time and establish your filtration cycles.

Preset Filter Cycles

The spa control system is designed with two filter cycles. The first filter cycle turns on 6 minutes after power is supplied to the spa. The second filter cycle begins 12 hours later. Filter cycles are pre-set for a two hour duration.

Note: To properly clean and maintain spa, a total filter time of at least four hours per day is recommended. If an ozonator is installed 6 hours is recommended.

Changing Filter Cycle Start Time

The start/stop times of the filter cycle begin 6 minutes after the spa set time is established. Set time is based on the time of day that the spa is **powered up**. Set time may only be changed by disconnecting power from the spa and reconnecting it at the desired start time. For example, if you want the filter cycle to begin at **9:00 PM**, turn off the breaker or disconnect the spa and reconnect it at **8:54 PM** (remember the 6 minute wait period). The cycle will begin at **9:00 PM** and will repeat beginning at **9:00 AM**. Each cycle will run for

the prescribed number of hours.

Changing Filter Cycle Duration

The duration of a filter cycle can be set in hour increments of 2, 4, 6, 8, or continuous. For example, a 2 hour cycle will complete once every 12 hours for a total of 4 hours per day.

The amount of time needed to filter your spa will depend on usage and ambient conditions. You will need to program your filter cycles based upon your personal use.

To change the duration of the filter cycles press the 'UP' or 'DOWN' button and then touch the 'JETS 1'.

Press the 'UP' or 'DOWN' button to adjust the cycle duration to the desired setting. After each press, the duration of the cycle will be displayed in the LED window as follows:

FIL2 = 2 Hours for each cycle, 4 hours per day

FIL4 = 4 Hours for each cycle, 8 hours per day

FIL6 = 6 Hours for each cycle, 12 hours per day

FIL8 = 8 hours for each cycle, 16 hours per day

FILC = Continuous filtration, 24 hours per day

To exit the filter-set procedure, touch 'JETS 1'. The LED window will display the current water temperature.

If a change is made to the duration while the spa is in a filtration cycle, it will take effect immediately. If the change is made outside a filtration cycle, it will take effect at the start of the next scheduled cycle.

NOTE: At the start of each filter cycle all equipment is activated for 5 minutes or less to clear the water in the pipes and ensure complete filtration.

Clean Up Cycle

After periods of heavy use, turn "PUMP 1" on for a four-hour clean up cycle.

Automatic Time Outs

Your **Vita Spa** is equipped with an automatic Time Out feature designed to protect both the equipment and the user. For your safety and to reduce unnecessary use of the pumps and lights, the Time Out feature turns selected accessories off automatically, as follows:

Accessory	Mode	Shuts Off In...
Pump 1	Low	4 hours
Pump 1	High	15 minutes
Pump 2	High	15 minutes
Blower		15 minutes
DOL Light		4 hour

THERMAL CREEP: see page 46

OZONE OPTION: see page 41

VITAROMA OPTION: see page 36

CIRC PUMP OPTION: see page 37

ENTERTAINMENT SYSTEM OPTION: see page 38

Blower / Champagne Air System OPTION: see page 36

AQUABURST LIGHTING see page 36

OPTIONS & FEATURES

ENGLISH

FRANCAIS

AquaBurst Lighting

For the Vita Spa that is equipped with a AquaBurst Lighting System.

This system has different color settings (sequences) to enhance your overall spa experience. Each time the AquaBurst system is turned ON by pressing the 'LIGHT' pad, it will begin a color lighting sequence.

Accessing Different Light Sequences

To change Sequences, press the 'LIGHT' button Off and On within a 5 second time period. The light will advance to the next color sequence mode. Continue until the desired color sequence mode is selected. The sequence will revert to the first sequence each time the light is turned off for more than 5 seconds.

When cycling through colors on the control panel, this is the program sequence for the AquaBurst lighting system.

1. Color-Wheel. This mode transitions the different colors.
2. White (All LEDs On).
3. Aqua (Green & Blue)
4. Purple (Red & Blue)
5. Blue
6. Amber (Red & Green)
7. Green
8. Red
9. Color Flash. This mode switches colors every few seconds.
10. Strobe. This mode flashes the LEDs on and off like a strobe light.

Champagne Air System Option

Your spa may be optionally equipped with a Champagne Air system to increase the performance and therapeutic action of the jets. To turn the Champagne Air system on and off, touch the 'AIR' button.

NOTE: The Champagne Air System will shut off automatically after 15 minutes.

NOTE: At the start of a filtration cycle, the Champagne Air System is activated to purge the lines and ensure complete filtration. Ensure that at least one air control is always fully open.

VitAroma / AROMATHERAPY SYSTEM

VitAroma Therapy offers the unique benefits of combining Aroma and Hydrotherapy. Simply defined, aromatherapy is the practice of using pure essential oils – the highly concentrated extracts of plants, herbs and flowers – to improve one's feelings of well being through the acute sense of smell

Your spa is equipped with an aroma dispenser located on the lip of the spa. To activate VitAroma, insert one of the Vita Spa's exclusive aromatherapy scents and turn on the VitAroma Induction System. You will immediately experience the wonder and pleasure of aromatherapy. It will soothe your senses and invigorate your spirit

To extend the lifespan of the VitAroma beads, it is recommended that they be removed from the spa and stored in the resealable packet after each use. VitAroma aromatherapy scents are available exclusively from Vita Spa Dealers.

VITA SPA

OPTIONS & FEATURES

CIRCULATION PUMP OR CIRC PUMP

OPTION:

Circulation pump (CIRC PUMP): 504 system

The circ pump will turn on immediately upon power up; the prime mode (Pr) does not apply to this feature. All other equipment will turn on briefly at the beginning of each filtration cycle to purge the plumbing lines.

If your spa is configured with the circ pump option it is designed to run constantly filtering the water. The circ pump will turn off when the water temperature is detected to be 3F above the set temperature to reduce overheat conditions. During the summer months or when the ambient air temperatures are above 90F it is important to monitor the water temperature to identify and manage potential thermal creep or overheat situations. See THERMAL CREEP on pg 37

Circulation pump (CIRC PUMP): 460 & 760 systems

The circ pump will turn on once you exit the the prime mode (Pr). All other equipment will turn on briefly at the beginning of each filtration cycle to purge the plumbing lines.

The circ pump operates continuously (24 hours) with the exception of turning off for 30 minutes when the water temperature reaches 3°F (1.5°C) above the set temperature (most likely to happen in warm climates). During the summer months

or when the ambient air temperatures are above 90F it is important to monitor the water temperature to identify and manage potential thermal creep or overheat situations. See THERMAL CREEP on pg 37

The mode settings will now work with circ pump. When your spa is in the Standard mode the heater will turn on as needed to maintain the set temperature. When it is in the Economy Mode, the heater will only be activated during the programmed filtration cycle time and will heat the water to the set temperature. In the Sleep mode the heater will only activate if the water temperature is 20°F (11°C) below the set temperature

Inversion Feature (460 & 760 systems)

The Control System includes an Inversion feature that makes it easy to read the LCD from inside or outside the spa. To invert the LCD display, touch the 'UP' or 'DOWN' button, followed by the 'AIR' button. Repeat the sequence to reverse the inversion process. If your spa is not equipped with the optional AIR feature, locate the position of the AIR button (next to the LIGHT button) and press in that general location

OPTIONS & FEATURES

ENGLISH

FRANÇAIS

Entertainment System (Optional)

Certain models are equipped with an audio system designed to provide the ultimate spa entertainment experience. Power to the entertainment system is supplied at spa start-up so it is always ready for your enjoyment.

Refer to the stereo Owner's Manual included in the Vita Spas Owner's pack for instruction on programming and using the entertainment system. Read all instructions carefully before using the entertainment system and **SAVE THE INSTRUCTIONS**.

The system includes a wireless remote. To operate the wireless remote, point it at the side skirt panel of the spa where the stereo is located.

Note: The wireless remote control is water resistant, not waterproof. Do not submerge the wireless remote control. It is not recommended to use the wireless remote from within the spa.

CAUTION: Risk of electrical shock.
Do not leave stereo compartment door open.

CAUTION: Risk of electrical shock.
Replace components only with identical components.

CAUTION: Risk of electrical shock.
When the power supply connections or power supply cord(s) are damaged; if water is entering the electrical equipment compartment area; if the protective shields or barriers are showing signs of deterioration; or if there are signs of other potential damage to the unit, turn off the unit and refer servicing to

a qualified service technician.

WARNING: Prevent Electrocutation.

Do not connect any auxiliary components (for example cable, additional speakers, headphones, additional audio/video components, etc.) to the system.

WARNING: Prevent Electrocutation.

Do not service this product yourself as opening or removing covers may expose you to dangerous voltage or other risk of injury. Refer all servicing to qualified personnel.

WARNING: Prevent Electrocutation.

These units are not provided with an outdoor antenna. When provided it should be installed in accordance with Article 810 of the National Electric Code, ANSI/NFPA 70.

WARNING: Prevent Electrocutation.

This unit should be subjected to periodic routine maintenance (for example once every 3 months) to make sure the unit is operating properly.

If your Control looks like this, your spa has the following features:



• Therapy Sequencer

Therapy Sequencer

Program #	Valve	Sequence												
P1 <i>Default</i>	V1	X	X	X	X	X	X	X	X	X	X	X	X	X
	V2	X	X	X	X	X	X	X	X	X	X	X	X	X
	V3	X	X	X	X	X	X	X	X	X	X	X	X	X
	V4	X	X	X	X	X	X	X	X	X	X	X	X	X
P2	V1	X				X				X				
	V2		X				X				X			
	V3			X				X				X		
	V4				X				X				X	
P3	V1	X					X		X					X
	V2		X				X		X					X
	V3			X		X				X			X	
	V4				X						X			
P4	V1	X		X		X		X		X		X		X
	V2	X		X		X		X		X		X		X
	V3		X		X		X		X		X		X	X
	V4		X		X		X		X		X		X	X
P5	V1	X		X		X		X		X		X		X
	V2		X		X		X		X		X		X	X
	V3	X		X		X		X		X		X		X
	V4		X		X		X		X		X		X	X
P6	V1	X		X		X		X		X		X		X
	V2		X		X		X		X		X		X	X
	V3		X		X		X		X		X		X	X
	V4	X		X		X		X		X		X		X
P7	V1	X		X		X		X		X		X		X
	V2	X		X		X		X		X		X		X
	V3	X		X		X		X		X		X		X
	V4		X		X		X		X		X		X	X
P8	V1	X		X		X		X		X		X		X
	V2		X		X		X		X		X		X	X
	V3		X		X		X		X		X		X	X
	V4		X		X		X		X		X		X	X
P9 <i>Random</i>	V1	X					X			X				
	V2			X					X			X		
	V3		X			X					X			
	V4				X			X						X

Therapy Sequencer

Certain models are equipped with a Jet Sequencer System that opens and closes a series of four solenoid valves to provide a therapeutic sequencing massage.

The control panel for the system allows you to start or stop operation, change programs, change speeds, or pause the system at any point in the program.

Starting the Sequencer

To energize the sequencing system, press the 'JETS 3' button on the topside control panel. Once energized, the sequencer will open all 4 solenoid valves and water will flow through all open jets. Two dashed lines will be displayed in the LCD window.

Push the 'ON/OFF' button one time and the LCD display will now show 'On'. This indicates that the system has been activated, but no changes will occur until a sequencing program has been selected.

Sequencing Programs





To start the sequencing program, push the **PROG** button one time. The LCD will momentarily display 'P2', and then alternate between 'P2' and 'S1'. The system is now running program 2 and sequencing speed 1. To change programs, push the 'MODE/PROG' button to step through the programs. The LCD will momentarily display the selected program (P3, P4, P5, etc.), and then alternately display the selected program with the sequencing speed. Refer to the Therapy Sequencer chart to see the order in which the valves will open and close for each program.

Sequencing Speeds

When first energized, the sequencing program will automatically go to the default speed, or 'S1'. To change the sequencing speed, push the 'SPEED' button once. The LCD will momentarily display the selected speed (S1, S2, or S3), and then alternately display the current program and the sequencing speed.

Pausing

To pause the sequencing action of the system at any point, simply press the 'PAUSE' button. This will suspend the operation of the valves and hold them either until the sequence is resumed or until the system is de-energized. The LCD display will alternate between 'PA' and the current program number. Press the 'PAUSE' button again to resume normal operation.

Pad	Use
 ON/OFF	<ul style="list-style-type: none"> • Activates the Sequencer
 PROGRAM	<ul style="list-style-type: none"> • Navigates between the nine therapy sequencer programs
 SPEEDS	<ul style="list-style-type: none"> • Navigates between the three therapy sequencer speeds
 PAUSE	<ul style="list-style-type: none"> • Pauses the therapy sequencer

MAINTENANCE

Water Chemistry

Water chemistry is critical in a spa system. Chemicals are used to sanitize the water and control the pH balance. The combination of high water temperature and small water volume means that the chemical balance must be watched carefully. It is recommended that you purchase a chemical start up kit, and the additional chemicals needed to maintain the proper/optimum chemical balance, from your dealer.

Sanitizing

Sanitizing the water destroys harmful organisms and keeps your spa healthy and safe. Three commonly used spa sanitizer or oxidizing agents are bromine, chlorine and ozone. Chlorine or bromine are chemicals that you add to the water. Ozone is a gas that is produced by an ozonator and injected into the water. It is important that a residual of sanitizer remain in your water. High water temperature, aeration and use will increase the need for sanitizer.

In addition to maintaining a residual, it is important to 'shock' your spa water periodically and after heavy use. This addition of substantial amounts of sanitizer super-chlorinates the water and oxidizes non-filterable organic residue. Allow the sanitizer level to drop back to the residual amount before using. Also use your Clean Up Cycle after heavy use for additional filtration. Tests should be done daily with your test kit to keep a chlorine or bromine residual of 3.0 to 5.0 ppm.

pH Level

pH is the balance of acidity and alkalinity in the water. Maintaining proper pH is important for the effectiveness of your sanitizer, for user comfort, and to prevent corrosion of the spa equipment.

Caution: Never mix two chemicals together.

Caution: Never store chemicals in the equipment compartment.

Caution: Do not use muriatic acid to balance pH as it will damage your spa surface and equipment.

Recommended Levels

pH:	7.2–7.6 (Ideal 7.4–7.6)
Sanitizer Residual:	3.5–5.0 ppm
Total Dissolved Solids:	100–200 ppm
Free Available Sanitizer:	3.0–5.0 ppm
Total Alkalinity:	80–100 ppm ideal for dichlor, trichlor, and bromine

NOTE: Make sure you use fresh test kit strips/chemicals. Test kits and test chemicals should be stored in a cool, dry location. Check the manufacturer's instructions to determine shelf life and expiration date.

Ozone:

Equipping your spa with the Powerworks™ Ozonator is a smart decision. The use of ozone in conjunction with spa sanitizing and water balancing chemicals helps to provide you with a cleaner, healthier spa and reduces chemical usage.

Sanitizing with Ozone

Spas vary in size, as well as frequency and conditions of use. For this reason you will need to establish your sanitizing program based upon your own personal use. When using ozone, you should start by balancing your water chemistry as you normally would. A spa should run and be ozonated a minimum of six hours per day. If your spa is heavily used, this time should be increased. Your spa produces ozone during the filtration cycles. The amount of a residual sanitizer (chlorine or bromine) that you maintain in the water will also vary depending on use. It is recommended that you maintain a residual of 3.0-5.0 ppm. Periodically, and after periods of heavy use, it is necessary to 'shock' your spa with large amounts of sanitizer.

NOTE: The ozonator is programed to turn on during a programed filter cycle and will be disabled if any button other than the light is pushed during this cycle.

NOTE: In spas equipped with a circ pump the ozonator can not be shut off and will remain on as long as the circ pump is running.

NOTE: Extra filtration can be provided by manually starting a clean-up cycle. Turn Pump 1 on in low speed. The pump will operate for 2 - 4 hours (depending on spa system) and then automatically turn off.

Specialty Chemicals

While ozone may significantly reduce the usage of specialty chemicals it is not a substitute for these chemicals. All chemicals should continue to be monitored, especially during periods of heavy usage and when

changing or replenishing the spa water.

Draining your Spa

NOTE: Always turn the circuit breaker off when you drain your spa. Do not turn the spa heater back on until you have full flow coming from the jets for several minutes..

Changing your spa water, cleaning the spa surface and filter are necessary because high concentrations of impurities caused by water evaporation, body oils, perfumes, and other contaminants may accumulate in the spa that cannot be filtered out.

NOTE: It is advisable to drain your spa and refill it with fresh water every six to eight weeks or more often, depending on the amount of use.

All spas are equipped with both external and internal drains. The external drain is used for draining the spa. The internal drain(s) are used to remove water from internal hoses when winterizing your spa (See pg. 39) or if the water is severely contaminated.

NOTE: Use a standard garden hose to direct the water to an appropriate disposal area.

The **external** drain valve is located in a compartment on the front panel. Open the compartment, pull the valve out, remove the outer black cap and connect a garden hose to the fitting. Turn the ring on the back of the valve counter-clockwise until it stops, then pull out to open the valve. Water will begin to flow. When flow stops, push in the valve, turn ring clockwise until it stops, remove hose and replace the cap.

The **internal** drain hose(s) is (are) located

behind the front access panel. Remove the access panel screws and the access panel. Locate the drain hose(s). For each hose drain valve, remove the cap, attach the garden hose, and turn the valve body 90° counter-clockwise. Water will begin to flow. When all water has been evacuated, turn the valve handle clockwise until it stops. Remove garden hose and replace the cap. Repeat for each internal drain hose.

NOTE: Do NOT attempt to use the pump to drain the spa.

NOTE: Close all drain valves and replace caps prior to refilling the spa.

NOTE: When refilling the spa, you may need to bleed air from the system. Refer to Priming Your Spa, pg. 16 for instructions.

Filter Maintenance

NOTE: It is not necessary to drain the spa in order to clean the filter.

The removable filter cartridges are located in the filter canister behind the weir door. The filter should be inspected / cleaned monthly during normal use, and more often when spa use is heavy.

Keep the filter cartridge clean! Clean the filter cartridge at least once every 90 days. A clogged filter decreases performance and degrades water quality.

To clean the filter cartridge:

1. Turn the pump off.
2. Remove skimmer lid on top of spa.
4. Remove filter cartridge from the filter canister

by grasping the top and unscrew counter-clockwise while lifting upwards.

5. Soak filter in a commercial filter cleaner/ degreaser, available from your Elite Spa dealer, per manufacturer's instructions. Hose out filter cartridge or replace with new cartridge, if needed.
6. Place filter cartridge back into filter canister, screw in clockwise DO NOT OVER TIGHTEN.
7. Replace the skimmer lid.
8. Turn the pump ON.

Replacing the filter cartridge annually is recommended to maintain optimum performance. Filter maintenance depends on usage.

Winterizing

In cold climates where freezing temperatures occur, special care is required to prevent the possibility of damage to the spa and equipment due to freezing. If you plan on using your spa during cold months, be sure your pump and heater are in good working order. The spa shell has been insulated to provide efficient operation in cold weather areas.

NOTE: If you elect not to drain your spa and the temperature is going to be below freezing for extended periods of time, it is best to operate the spa in the standard mode with the temperature set at the maximum high temperature of 104°F (40°C), especially if there is a power outage threat. This will help keep the spa water from freezing if you have a power failure.

If you do not intend to use your spa during the winter months and there is danger of freezing, use the following steps to winterize your spa: Winterizing a spa if done properly is a

complicated procedure. **When at all possible this should be done by a spa service center.**

A freeze damaged spa can be expensive to fix. With that in mind here are some basic winterizing tips that will help you remove enough of the water and add enough RV Antifreeze to keep your plumbing from freezing.

What you will need;

1. A wet /dry (shop vac) vacuum.
 2. 1 to 3 gallons of RV antifreeze (nontoxic, used in Recreational Vehicles water tanks)
 3. Channel lock pliers (16" works best for most tubs)
 4. A funnel
 5. Time, expect two to three hours.
- Now that you have those things,
- Drain the spa
 - Vacuum all of the jets and injectors, until there is no more water coming out.
 - Remove your filter and vacuum at the filter plumbing.
 - If you have an air injectors, turn power on , and make sure the pump(s) are NOT running and the heater is not firing; (generally this can only be accomplished by unplugging the pumps from the control box and removing the connections from the heater) then turn your air blower on until water no longer comes out of air holes. Then turn the power back off.
 - Loosen the plumbing connections at your pump and at your heater and remove the freeze plugs on the front face of the pump(s). Vacuum up any water that comes out.
 - Reconnect the plumbing to the heater, the freeze plugs and the lower of the two connections on your pumps.
 - Add RV antifreeze to the pump using your funnel. Most pumps will take approx. 4 oz.

- Reattach your pump unions.
- Add approximately 1 oz. of RV anti-freeze to each of the jets. (use funnel)
- Add RV anti-freeze to the plumbing that is attached to your filter until it runs out of the intakes in the foot well of the spa. (This is not possible in all spas)
- Add anti-freeze to the air injectors, this can be tedious but is worth the effort.

In climates that get heavy snows it is a good idea to place some plywood over your cover to help reinforce it. Then cover the spa with a tarp, and strap the tarp down, this will help keep winter winds from getting to your cover.

In the spring, or when you are ready to start the tub back up.

- Make sure that all fittings are tight.
- Fill with cool water
- Turn the power on.
- Run the jets on high speed for 30 minutes.
- Several times during the 30 minutes that you are running your pump, turn your air blower on and off. This will purge the air lines.
- Drain the spa through all drain lines supplied
- Put your filter in the spa.
- Refill and treat chemically like you would during a water change.

Spa Cabinet Care:

The cabinets are made of Duramaax™, a high quality alternative to wood that is virtually maintenance free, requiring no staining, sealing, or waxing.

To clean the spa cabinet, rinse dirt and dust regularly with clear water. To remove stubborn dirt, grime, and mild discoloration, wash with a mild detergent and warm water.

Protect spa finish - always keep cover on the spa when not in use.

Spa Surface Care and Cleaning

Your spa shell surface is made of acrylic. A minimum amount of care and cleaning will keep your spa looking new for years. Use a spa cleaner for residue and lime build-up at the water level of the spa surface. It may be necessary to lower the water level 5-7 cm before cleaning to avoid polluting the spa. Cleaner can be applied to the acrylic surface with a soft cloth and wiped clean. Use a non-abrasive household cleaner to clean your spa shell or use a mild dishwashing detergent. Rinse well and dry with a clean cloth.

Never use abrasive cleaners.

NOTE: Do not allow the acrylic surface to come in to contact with products such as acetone (nail polish remover), nail polish, dry cleaning solution, lacquer thinners, gasoline, pine oil, solvents, etc.

Remove dust and dry dirt with a soft, damp cloth. Avoid using razor blades or other sharp instruments that might scratch the surface.

Light Bulbs

The Spa light bulb is serviceable from inside the spa cabinet. Remove the side panel and insulation closest to the light; locate the bracket that holds the bulb. Turn the black bulb holder 90 degrees counter-clockwise; remove from bracket. Pull bulb straight out and replace. Insert bulb holder back into bracket and turn 90 degrees clock-wise to secure.

Spa Cover Care:

Proper care is easy: Once a month, clean and condition the cover according to the maintenance instructions that came with your cover

Even if you don't condition your top vinyl every month, we recommend you give one good treatment just before snow or ice. If possible, treat during the winter too.

After every snow fall or ice storm, use a soft broom to remove the accumulation from your Spa cover — this will help preserve your foam cores, and a broom won't damage the vinyl. Handle tie-down straps and handles with care, because in really cold climates, vinyl can crack, since it will not stretch.

For added security in windy and storm conditions, consider using additional tie down straps which lock down tight.

Remove foam cores from the vinyl encasement. Mix two gallons of water, a teaspoon of mild dishwashing soap and one cup of bleach. With a soft bristle brush, scrub the inside of the encasement thoroughly. Then take a wash cloth and wipe down each foam core. Rinse both well. Place the

encasement in the sun and foam cores in the shade to dry. (Do not put foam cores in the sun – they will melt!)

Once everything is dry, spray the cores and inside the encasement with a mildew inhibitor like Pine Sol®. Allow all to dry completely, and then reassemble. The key here is to maintain proper water chemistry to avoid mildew.

If you are using WD-40 to free the Sure-Locs, try using a Q-tip to keep the WD-40 away from your cabinet. (It can damage the finish.)

Thermal Creep

Your Vita spa is manufactured with energy-efficient components and systems that capture heat generated by the equipment, then transfer that heat back to the spa water. In warmer climates or in situations with extended run times, “Thermal Creep” may occur. Thermal Creep is a condition whereby the actual water temperature is higher than the set temperature.

To manage “Thermal Creep” you may:

- Vent your cover
- Open all air controls
- Set your filtration cycles to run during the cooler times of the day or at night
- Reduce the length of your filter cycles
- Visit your local Vita Spa distributor for additional guidance

Thermal Creep only occurs in well-insulated hot tubs. It is not an indication that something is wrong with your spa or its equipment

COMMON PANEL MESSAGES

Message...	What it is...	What it means...
Pr	Priming mode	Spa is in normal Priming Mode operation
SLP or SL	Sleep mode	Spa is in normal Sleep Mode operation
ECN or EC	Economy mode	Spa is in normal Economy Mode operation
STD or ST	Standard mode	Spa is in normal Standard Mode operation
ICE or IC	Freeze condition	Heater will come on to keep water above 45°F
--- or --	Water temperature	Current water temperature not measured

Message	Meaning	What Happens...	Possible Causes	Action Required
	No message on Display Power has been cut off to the spa			Verify power going to spa. Check for tripped breaker or blown fuse. The control panel will be disabled until power returns. Spa setting will be preserved until the next power up.
HH or OHH	“Overheat” - *One of the sensors has detected 118F / 47.8C at the heater	The spa will shut down and will automatically reset once the water temperature has cooled to 108F (42C)	~ Low Water Flow ~ Faulty Equipment	DO NOT ENTER THE WATER. Remove the spa cover and allow water to cool. ~ Verify all slice valves are locked open ~ Verify Actual water temperature with a digital Thermometer ~ Verify normal operation of pump 1 ~ Verify all spa jets are open. Once the heater has cooled, reset by pushing any button. If the spa does not reset, shut off the power to the spa and call your dealer or service organization.

* - Even when the spa is shut down, some equipment will turn on if freeze protection is needed.

Message	Meaning	What Happens...	Possible Causes	Action Required
OH or OHS	“Overheat” - The spa has shut down. * One of the sensors has detected that the spa water is 110F / 43.5C	The spa will shut down and will automatically reset once the water temperature has cooled to 108F (42C)	~ Low Water Flow ~ Faulty Equip- ment ~ Extended Filtra- tion Cycles FC - or Continious Filtration ~ Thermal Creep	DO NOT ENTER THE WATER. Remove the spa cover and allow water to cool. At 107F / 41.7C, the spa should automatically reset. ~ Verify all slice valves are locked open ~ Ver- ify Actual water tem- perature with a digital Thermomiter ~ Verify normal operation of pump 1 ~ Verify all spa jets are open This con- dition can be caused by “thermal creep”, additional information on ways to manage and prevent thermal creep are located in this manual. If the spa does not reset, shut off the power to the spa and call your dealer or service organization.
SA or SnA	Spa is shut down. * The sensor that is plugged into the “A” jack is not working	The spa will shut down	~ Disconnected or defective sen- sor	If the problem persists, contact your dealer or service organization. May appear temporar- ily in an over heat or freeze condition
Sb or Snb	Spa is shut down. * The sensor that is plugged into the Sensor “B” jack is not working	The spa will shut down	~ Disconnected or defective sen- sor	If the problem persists, contact your dealer or service organization. May appear temporar- ily in an over heat or freeze condition

Message	Meaning	What Happens...	Possible Causes	Action Required
Sn or SnS	Sensors are out of balance.	If alternating with spa temperature, it may just be a temporary condition. If flashing by it itself, spa is shut down*	May appear temporarily in an over heat or freeze condition	If the problem persists, contact your dealer or service organization. May appear temporarily in an over heat or freeze condition
HL or HFL	A significant difference between temperature sensors has been detected. This could indicate a flow problem	Heater will shut down while spa continues to function normally	~ Low water level ~ Dirty spa filter(s) ~ Closed spa jets	Verify water level is within 1/8" from top of weir door - make sure all jets are open, all pumps are operating normally and the spa filter(s) are clean. If the problem persists contact your dealer or service organization
LF	Persistent low flow problems. (Displays on the fifth occurrence of HL message within 24 hours) Heater is shut down, but other spa functions continue to run normally	Heater will shut down while spa continues to function normally	~ Low water level ~ Dirty spa filter(s) ~ Closed spa jets	Follow action required for HL message. Heating capability of the spa will not reset automatically; you may press any button to reset.
dr	Lack of water flowing through the heater	Spa is shut down for 15 minutes	Low water Level, poor flow, or air bubbles detected in the heater.	Verify water level is within 1/8" from top of weir door - make sure all jets are open, all pumps are operating normally and the spa filter(s) are clean. Spa will reset in 15 minutes, if the problem persists contact your dealer or service organization

Message	Meaning	What Happens...	Possible Causes	Action Required
dy	Inadequate water detected in the heater (Displays on the third occurrence of dr message) Spa is shut down.*	Spa is shut down.	Possible inadequate water, poor flow, or air bubbles detected in the heater.	Verify water level is within 1/8" from top of weir door - make sure all jets are open and all pumps are operating normally - verify all jets are open and the spa filter(s) are clean. Spa will not automatically reset, press any button to reset manually. If the problem persists contact your dealer or service organization
IC or ICE	"ICE" - Potential freeze condition detected	All Pumps and Blower are ON for at least 4 Minutes After Temp is 45°F (7.2°C) or Above You will not have control of the components during freeze protection. If you spa is configured for "low" amperage your heater may not activate until the freeze condition has cleared.	Cold water - common at start up when the water temperature is below 45°F (7.2°C)	No action required. All equipment will automatically activate regardless of spa status.
HOT or StU	A pump has been running too long.	This could contribute to over heat conditions		SHUT THE POWER TO THE SPA OFF AND CONTACT YOUR DEALER OR SERVICE CENTER.
46				VITA SPA

COMMON WATER PROBLEMS

Problem	Usual Cause	Solution
Cloudy Water	<ul style="list-style-type: none"> - Inadequate filtration/ dirty filter - Excessive oils/organic matter - Improper sanitation/ bacteria - High pH and/or high alkalinity 	<ul style="list-style-type: none"> - Check to make sure the filter is running properly; clean filter with a filter cleaner or degreaser - Shock the spa with a chlorine or bromine sanitizer, or other shock treatment product - Increase sanitizer level to balance water and shock if needed - Adjust pH; add appropriate sodium bisulfate product - Use clarifier <p>NOTE: If using an ozone generator, consult with your dealer before using polymer based clarifiers</p> <ul style="list-style-type: none"> - Depending on the severity, drain the spa completely, clean and refill
Water Odor	<ul style="list-style-type: none"> - Excessive organics or chloramines; insufficient free available sanitizer - Improper sanitation - Inadequate filtration - Low pH 	<ul style="list-style-type: none"> - Shock the spa with a chlorine or bromine sanitizer/shock, or other shock treatment product - Increase sanitizer level to balance water; shock if needed - Check to make sure the filter is running properly; clean filter with a filter cleaner or degreaser - Raise pH with sodium bicarbonate product. If metals are present, add chelating agent.
Chlorine Odor	<ul style="list-style-type: none"> - Too many chloramines/ insufficient free available chlorine - Low pH 	<ul style="list-style-type: none"> - Shock the spa with a chlorine sanitizer/ shock, or non-chlorine shock treatment - Adjust pH; raise pH with sodium bicarbonate product
Bromine Odor/ Yellow Water	<ul style="list-style-type: none"> - Low pH 	<ul style="list-style-type: none"> - Adjust pH; raise pH with sodium bicarbonate product

Problem	Usual Cause	Solution
Musty Odor	- Bacterial or algae growth	- Shock spa with a chlorine or bromine sanitizer/ shock, of equivalent shock treatment product. If problem is visible, drain, clean, refill and balance spa
Foaming/ Scum Ring Around the tub	- Build up of body oils, lotion and chemicals resulting from soap or detergent	- Skim foam off using your leaf net or drain and refill
Algae	- pH Imbalance - Low free chlorine or bromine	- Adjust pH - Shock with a chlorine or bromine
Eye Irritation	- Low pH - Insufficient free available chlorine	- Raise pH with sodium bicarbonate product - Shock with a chlorine sanitizer/shock or other shock treatment product
Skin Irritation/ Rash	- Unsanitary/polluted water - Soaking too long - Chemicals not balanced, excessive ozone	- Keep recommended sanitizer residual at all times; superchlorinate or use a non-chlorine shock treatment - Soak for smaller intervals, such as 15 minutes - Correct chemical imbalance
Scale	- Too much calcium dissolved in water - pH and total alkalinity too high	- Add a scale control product. Adjust total alkalinity and pH levels by adding the appropriate sodium bisulfate product; for concentrated scale deposits - Drain spa, scrub the scale off, refill the spa and balance the water
Erratic pH Test Results/Unusual pH Test Color	- Sanitizer level too high - Old pH indicator dye	- Test the pH, when the sanitizer level is below 5 ppm - Replace the pH indicator dye / test strips

Problem	Usual Cause	Solution
Sanitizer Dissipating Too Rapidly	<ul style="list-style-type: none"> - Excessive organics in water - Temperature too high - Low pH - Low calcium hardness - Low total alkalinity 	<ul style="list-style-type: none"> - Increase shock dosage; add sanitizer; shower before entering spa - Reduce temperature - Raise pH with sodium bicarbonate product - Use chelating agent if metals are present. Keep proper pH level (7.2 to 7.6). - Use chelating agent if metals are present. Maintain minimum 150-200 ppm calcium hardness - Use chelating agent if metals are present. Maintain proper alkalinity for type of sanitizer used.

NOTE: If your source water has a high metal or mineral content, a specialty chemical should be used to avoid staining or accumulation of deposits. These guidelines cover the most common water problems. Contact your dealer for further information regarding chemical control issues.

COMMON HARDWARE PROBLEMS

ENGLISH

FRANCAIS

Problem	Usual Cause	Solution
System not operating	<ul style="list-style-type: none"> - House circuit breaker tripped or in OFF position 	<ul style="list-style-type: none"> - Reset circuit breaker on house breaker panel
Heater not operating	<ul style="list-style-type: none"> - Water level too low - Heater mode not selected - No power to heater 	<ul style="list-style-type: none"> - Add water to reach 1/8" below the top of the weir door - Refer to temperature/heater functioning. See Control instructions pg. 20, 26, or 31 - Check house circuit breaker - Contact dealer
Water not clean	<ul style="list-style-type: none"> - Clogged or blocked floor suction or skimmer - Filter clogged (dirty) - Poor water chemistry - Insufficient filtering time - Improper maintenance - High content of solids in water 	<ul style="list-style-type: none"> - Clean floor suction/skimmer. Remove blockage - Clean or replace - See Maintenance section pg. 41 - Run filtration mode longer - Contact dealer - Use clarifier or drain and refill spa
Abnormal water usage	<ul style="list-style-type: none"> - Excessive evaporation and/or splashing 	<ul style="list-style-type: none"> - Use spa cover and refill as necessary
Overheating	<ul style="list-style-type: none"> - High ambient temperature 	<ul style="list-style-type: none"> - Contact dealer
Low water flow from jets	<ul style="list-style-type: none"> - Operating in FILTER mode-low speed - Clogged or blocked suction or skimmer - Dirty filter - Jets in OFF position - Slice valves closed 	<ul style="list-style-type: none"> - Select hi-speed jets - Clean floor suction/skimmer. Remove blockage - Clean or replace - Open jets - Contact dealer
Noisy pump and motor	<ul style="list-style-type: none"> - Clogged floor suction or skimmer - Low water level - Damaged or worn motor bearings 	<ul style="list-style-type: none"> - Clean floor suction/skimmer - Add water to normal water level (15cm below lip) - Contact dealer

Problem	Usual Cause	Solution
No water flow from jets	<ul style="list-style-type: none"> - Pump not primed - Adjustable jets turned off - House circuit breaker tripped, no power to system - Faulty pump or motor - Pump surges - Slice valves closed 	<ul style="list-style-type: none"> - See Priming section, pg. 16 - Turn on jets - Reset circuit breaker at house panel - Low water. Check level on Weir door - Contact dealer
Water leakage from under spa	<ul style="list-style-type: none"> - Check unions & drain hoses 	<ul style="list-style-type: none"> - Close or tighten as necessary
No air flow from jets	<ul style="list-style-type: none"> - Air control not open - Jet nozzle not seated properly - Jet nozzle missing 	<ul style="list-style-type: none"> - Open control - Check jet nozzles - Inspect jets and replace as needed
Motor will not operate	<ul style="list-style-type: none"> - House circuit breaker tripped or in OFF position - Improper or defective wiring or electrical supply - Thermal Overload Protection switch tripped 	<ul style="list-style-type: none"> - Reset circuit breaker - Contact dealer - Auto reset after motor has cooled. Contact dealer if motor continues to cycle tripped
Black powder film around water line	<ul style="list-style-type: none"> - Wearing in of turbo/blower brushes 	<ul style="list-style-type: none"> - Will disappear after use
The spa will not shut off	<ul style="list-style-type: none"> - Spa trying to heat - Spa is in filter cycle - Spa is in Standard Mode 	<ul style="list-style-type: none"> - Check 'Set Temperature' in Standard Mode - Normal. No need to change - Check mode setting

SPA SOAKING GUIDELINES

ENGLISH

FRANÇAIS

1. Persons with heart disease, diabetes, blood pressure or circulatory abnormalities, a serious illness, or pregnant women should not enter a spa without prior consultation with their doctor.
2. People with skin, ear, genital or other body infections, open sores, or wounds should not use the spa because of the possibility of spreading infection.
3. Before entering, look at the water in your spa. If there is cloudiness, foaming, or if a strong chlorine smell is present, the water needs treatment. Properly maintained water will greatly reduce potential skin rash (pseudomonas). Ask your Authorized Vita Spa Dealer for guidance.
4. Shower with soap and water before and after using the spa. Showering before use removes many common skin bacteria, perspiration, lotions, deodorants, creams, etc. that may reduce the effectiveness of the sanitizer and lessen the ability of the filter to work efficiently. Showering after use will help reduce skin irritation that may result from contact with spa chemicals.
5. Enter the spa slowly and cautiously. Be careful of your footing, and allow your body to gradually adjust to the water temperature. Exit slowly to accommodate relaxed leg muscles and possible light-headedness.
6. Soaking for too long may cause some users to feel nauseous, dizzy, or light-headed. If you wish to soak in high temperature water (104°F, 40°C), leave the spa after 15 minutes, shower, cool down and then return for another brief stay. In lower temperatures (e.g. 98.6°F, 37°C, normal body temperature) most people can comfortably and safely soak for longer periods at one sitting. If you have any questions about what's right for you, your family, or other guests, consult your doctor.
7. Be sure you check the water temperature before entering, and while using the spa.
8. Never use the spa while under the influence of alcohol.
9. Consult your doctor about potential harmful effects of using drugs or medications while hot water soaking.
10. **Never use the spa when you are alone.**
11. **Never allow children or elderly adults to use the spa unsupervised.**

167 SERIES SYSTEM WIRING DIAGRAM

Wiring Diagram For Spa Models Intrigue (240V)



167 - PN 54293-02

01/07/10

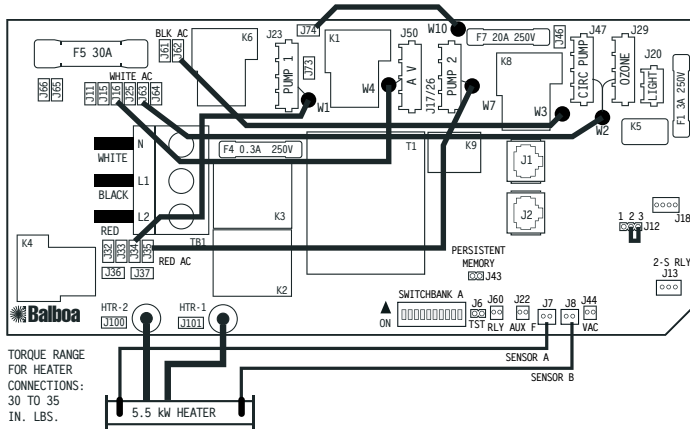

CONNECT ONLY TO CIRCUITS PROTECTED BY A CLASS A GFCI.

A DISCONNECTING MEANS MUST BE INSTALLED WITHIN SIGHT FROM THE EQUIPMENT AND AT LEAST 5 FEET (1.52 M) FROM THE INSIDE WALLS OF THE POOL, SPA, OR HOT TUB.

CONTROL PANEL TO J1

USE COPPER CONDUCTORS ONLY.
EMPLOYER UNIQUEMENT
DES CONDUCTEURS DE CUIVRE.
#6 AWG MIN. WIRE= 90°

FOR SUPPLY CONNECTIONS,
USE CONDUCTORS SIZED ON THE
BASIS OF 60°C AMPACITY BUT
RATED MINIMUM OF 90°C.

TORQUE RANGE FOR
MAIN TERMINAL BLOCK:
27-30 IN. LBS.

SWITCHBANK A OFF (DOWN)

TEST MODE OFF	◀ A1
STANDARD/ECON/SLEEP MODES	◀ A2
DIG OR LT DUPLEX PANEL	A3 ▶
AUX FREEZE (MUST BE OFF)	◀ A4
CIRC WITH 1SPD PUMP1	◀ A5
60HZ	◀ A6
BLOWER ON MAIN PANEL	◀ A7
DEGREES F	◀ A8
NON CIRC	◀ A9
HIGH AMP MODE	◀ A10

SWITCHBANK A ON (UP)

TEST MODE ON	▶ A1
STANDARD MODE ONLY	▶ A2
MINI PANEL	▶ A3
AUX FREEZE (MUST BE OFF)	▶ A4
CIRC WITH 2SPD PUMP1	▶ A5
50HZ	▶ A6
BLOWER ON AUX PANEL	▶ A7
DEGREES C	▶ A8
CIRC ON 24HRS	▶ A9
LOW AMP MODE	▶ A10

ALL UNUSED SWITCHES SHOULD BE OFF

AS MANUFACTURED

LOCATION	DEVICE	VOLTS	AMPS	FROM	TO
J23	2 SPD P1	240V	12A	W1	RED AC
J47	CIRC PUMP	120V	4A	W2	WHT AC
J17/26	1 SPD P2	240V	12A	W7	RED AC
J50	A V	120V	2A	W4	WHT AC
J29	OZONE	120V	1A	W2	WHT AC
J20	LIGHT	12V	12W	HTR TERM	HTR 1/2
HTR	HEATER	240V	5.5kW	HTR TERM	HTR 1/2

TOTAL OUTPUT AMP DRAW NOT TO EXCEED MAX INPUT RATING OF SPA

*ALL DEVICES LABELED 240V WILL RUN AT 120V WHEN HEATER IS CONVERTED TO 120V
CIRC PUMP IS AN OPTIONAL DEVICE. ADJUST DIP SWITCHES A5 & A9 ACCORDINGLY.

USE EARTH GROUND CONNECTIONS AS INDICATED INSIDE THE SYSTEM ENCLOSURE

460 SERIES SYSTEM WIRING DIAGRAM

ENGLISH

FRANCAIS

Wiring Diagram For Spa Models Joli, Cabaret, Nuage, Passion, Prestige, & Chateau (240V)



460 - PN 54301-04

1/07/10

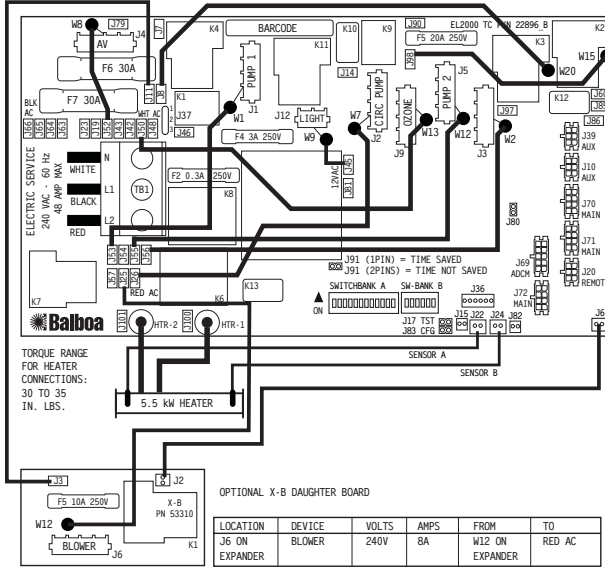

CONNECT ONLY TO CIRCUITS PROTECTED BY A CLASS A GFCI.
A DISCONNECTING MEANS MUST BE INSTALLED WITHIN SIGHT FROM THE EQUIPMENT AND AT LEAST 5 FEET (1.52 M) FROM THE INSIDE WALLS OF THE POOL, SPA, OR HOT TUB.

USE COPPER CONDUCTORS ONLY.
EMPLOYER UNQUEMENT DES CONDUCTEURS DE CUIVRE.
#6 AWG MIN. WIRE= 75°
FOR SUPPLY CONNECTIONS, USE CONDUCTORS SIZED ON THE BASIS OF 60°C AMPACITY BUT RATED MINIMUM OF 75°C.

TORQUE RANGE FOR MAIN TERMINAL BLOCK (TB1): 27-30 IN. LBS.

A2, A3, AND A4 WORK IN COMBINATION. I.e A2 AND A3 IN THE ON POSITION AND A4 IN THE OFF POSITION WILL ALLOW 3 HIGH SPEED PUMPS TO RUN WITH THE HEATER.

SWITCHBANK B IS DISABLED IN THIS CONFIGURATION.

CFG JUMPER J83 MUST BE ON BOTH PINS.

TORQUE RANGE FOR HEATER CONNECTIONS: 30 TO 35 IN. LBS.

OPTIONAL X-B DAUGHTER BOARD

LOCATION	DEVICE	VOLTS	AMPS	FROM	TO
J6 ON EXPANDER	BLOWER	240V	8A	W12 ON EXPANDER	RED AC

5 PROTECTED BY A CLASS A GFCI.
UST BE INSTALLED WITHIN SIGHT FROM
AST 5 FEET (1.52 M) FROM THE
L, SPA, OR HOT TUB.

ML (MAIN) PANELS
J70, J71 or J72

MLY.

SWITCHBANK A OFF (DOWN) SWITCHBANK A ON (UP)

TEST MODE OFF	A1	TEST MODE ON
DON'T ADD 1 HS PUMP W/HTR	A2	ADD 1 HS PUMP WITH HEAT
DON'T ADD 2 HS PUMPS W/HTR	A3	ADD 2 HS PUMPS WITH HEAT
DON'T ADD 4 HS PUMPS W/HTR	A4	ADD 4 HS PUMPS WITH HEAT
NOT ASSIGNED	A5	NOT ASSIGNED
NOT ASSIGNED	A6	NOT ASSIGNED
NOT ASSIGNED	A7	NOT ASSIGNED
NOT ASSIGNED	A8	NOT ASSIGNED
NOT ASSIGNED	A9	NOT ASSIGNED
NO EDIT	A10	EDIT
NOT ASSIGNED	A11	NOT ASSIGNED
STORE SETTINGS	A12	MEMORY RESET

SWITCHBANK B OFF (DOWN)

SWITCHBANK B ON (UP)

NOT ASSIGNED	B1	NOT ASSIGNED
NOT ASSIGNED	B2	NOT ASSIGNED
NOT ASSIGNED	B3	NOT ASSIGNED
NOT ASSIGNED	B4	NOT ASSIGNED
NOT ASSIGNED	B5	NOT ASSIGNED
NOT ASSIGNED	B6	NOT ASSIGNED

ALL UNUSED SWITCHES SHOULD BE OFF

LOCATION	DEVICE	VOLTS	AMPS	FROM	TO
J1	2 SPD P1	240V	12A	W1	RED AC
J2	CIRC PUMP	240V	4A	W7	RED AC
J3	NOT USED	240V		W2	RED AC
J4	AV	120V	2A	W8	WHT AC
J5	2 SPD P2	240V	12A	W12	RED AC
J9	OZONE	120V	1A	W13	WHT AC
J12	LIGHT	12V**	2A	W9	J45
HTR	HEATER	240V	5.5KW	HTR TERM	HTR 1/2

**J37 MUST ALSO BE SET ON PINS 2 AND 3 FOR A 12V SPA LIGHT

TOTAL OUTPUT AMP DRAW NOT TO EXCEED MAX INPUT RATING OF SPA
USE EARTH GROUND CONNECTIONS AS INDICATED INSIDE THE SYSTEM ENCLOSURE

504 SERIES SYSTEM WIRING DIAGRAM

Wiring Diagram For Spa Model Elegant, Monarque, Prestige, Envy, & Grand (240V)



MX504SZ - PN 55257
01/19/10

CONNECT ONLY TO CIRCUITS PROTECTED BY A CLASS A GFCI.
A DISCONNECTING MEANS MUST BE INSTALLED WITHIN SIGHT FROM THE EQUIPMENT AND AT LEAST 5 FEET (1.52 M) FROM THE INSIDE WALLS OF THE POOL, SPA, OR HOT TUB.

USE COPPER CONDUCTORS ONLY.
EMPLOYER UNIQUEMENT
DES CONDUCTEURS DE CUIVRE.
#6 AWG MIN. WIRE= 90°
FOR SUPPLY CONNECTIONS.
USE CONDUCTORS SIZED ON THE BASIS OF 60°C AMPACITY BUT RATED MINIMUM OF 90°C.

TORQUE RANGE FOR MAIN TERMINAL BLOCK:
27-30 IN. LBS.

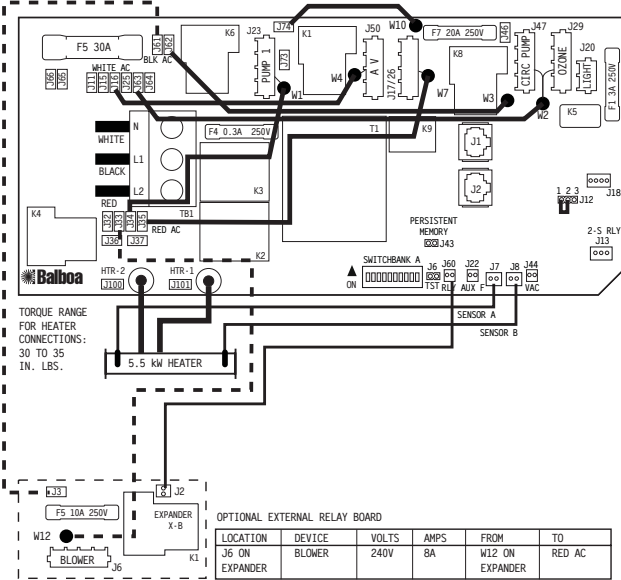

CONTROL PANEL TO J1

SWITCHBANK A OFF (DOWN)

SWITCHBANK A ON (UP)

TEST MODE OFF	◀ A1	TEST MODE ON
SEE TABLE 1	◀ A2	SEE TABLE 1
PUMP2 DISABLED	A3 ▶	PUMP2 ENABLED
AUX FREEZE (MUST BE OFF)	◀ A4	AUX FREEZE (MUST BE OFF)
1 SPEED PUMP 1	A5 ▶	2 SPEED PUMP 1
1 SPEED PUMP 1	◀ A6	50HZ
60HZ	◀ A7	EXT RELAY BOARD ENABLED
EXT RELAY BOARD DISABLED	◀ A8	DEGREES C
DEGREES F	◀ A9	CIRC ENABLED
NON CIRC	A10 ▶	SEE TABLE 1

ALL UNUSED SWITCHES SHOULD BE OFF

TABLE 1

# OF HIGH-SPEED PUMPS AND/OR BLOWER WITH HEATER	A2	A10
0 HIGH-SPEED PUMP OR BLOWER	OFF	OFF
1 HIGH-SPEED PUMP OR BLOWER	ON	OFF
2 HIGH-SPEED PUMPS OR 1 HIGH-SPEED PUMP AND BLOWER	OFF	ON
3 HIGH-SPEED PUMPS OR 2 HIGH-SPEED PUMPS AND BLOWER	ON	ON

LOCATION	DEVICE	VOLTS	AMPS	FROM	TO
J23	2 SPD P1	240V	12A	W1	RED AC
J47	CIRC PUMP	120V	4A	W2	WHT AC
J17/26		240V		W7	RED AC
J50	AV	120V	2A	W4	WHT AC
J29	OZONE	240V	1A	W2	RED AC
J20	LIGHT	12V	12W		
HTR	HEATER	240V	4.0kW	HTR TERM	HTR 1/2

TOTAL OUTPUT AMP DRAW NOT TO EXCEED MAX INPUT RATING OF SPA

USE EARTH GROUND CONNECTIONS AS INDICATED INSIDE THE SYSTEM ENCLOSURE

760 SERIES SYSTEM WIRING DIAGRAM

ENGLISH

FRANCAIS

Wiring Diagram For Spa Models Rendezvous & Mystique (240V)



760 – PN 54289-05

01/08/10

LOCATION	DEVICE	VOLTS	AMPS	FROM	TO
J1	2 SPD P1	240V	12A	W1	RED AC
J2	NOT USED	120V		W6	WHT AC
J3	CIRC PUMP	120V	4A	W7	WHT AC
J4	OZONE/UV	120V	1A	W13	WHT AC
J5	NOT USED	120V	2A	W8	WHT AC
J6	BLOWER	240V	4.5A	W12	RED AC
J7	NOT USED	120V	2A	W2	WHT AC
J8	NOT USED	120V		W5	WHT AC
J9	NOT USED	120V		W5	WHT AC
J10	SPA LIGHT	12V	2A	W9	J81 12VAC
J11	2 SPD P2	240V	12A	W14	RED AC
J12	1SPD P3/SEQ	240V	12A	W10	RED AC
HTR	HEATER	240V	5.5kW	HTR TERM	HTR 1/2

J83 ON 2 PINS

SWITCHBANK A OFF (DOWN)



SWITCHBANK A ON (UP)

TEST MODE OFF	◀ A1	TEST MODE ON
DON'T ADD 1 HS PUMP W/HTR	◀ A2	ADD 1 HS PUMP WITH HEAT
DON'T ADD 2 HS PUMPS W/HTR	◀ A3	ADD 2 HS PUMPS WITH HEAT
DON'T ADD 4 HS PUMPS W/HTR	A4 ▶	ADD 4 HS PUMPS WITH HEAT
NOT ASSIGNED	◀ A5	NOT ASSIGNED
NOT ASSIGNED	◀ A6	NOT ASSIGNED
NOT ASSIGNED	◀ A7	NOT ASSIGNED
NOT ASSIGNED	◀ A8	NOT ASSIGNED
NOT ASSIGNED	◀ A9	NOT ASSIGNED
NO EDIT	◀ A10	EDIT
SPECIAL AMPERAGE RULE ON	◀ A11	SPECIAL AMPERAGE RULE OFF
STORE SETTINGS	◀ A12	MEMORY RESET

SWITCHBANK B OFF (DOWN)

SWITCHBANK B ON (UP)

NOT ASSIGNED	◀ B1	NOT ASSIGNED
NOT ASSIGNED	◀ B2	NOT ASSIGNED
NOT ASSIGNED	◀ B3	NOT ASSIGNED
NOT ASSIGNED	◀ B4	NOT ASSIGNED
NOT ASSIGNED	◀ B5	NOT ASSIGNED
NOT ASSIGNED	◀ B6	NOT ASSIGNED
NOT ASSIGNED	◀ B7	NOT ASSIGNED
NOT ASSIGNED	◀ B8	NOT ASSIGNED
NOT ASSIGNED	◀ B9	NOT ASSIGNED
NOT ASSIGNED	◀ B10	NOT ASSIGNED
NOT ASSIGNED	◀ B11	NOT ASSIGNED
NOT ASSIGNED	◀ B12	NOT ASSIGNED

NOTE:
A2, A3, AND A4 WORK IN COMBINATION. I.E., A2 AND A3 IN THE ON POSITION AND A4 IN THE OFF POSITION WILL ALLOW 3 HIGH SPEED PUMPS TO RUN BEFORE THE HEATER IS DISABLED.

SWITCHBANK B IS DISABLED IN THIS CONFIGURATION. UNLISTED DIP SWITCHES IN SWITCHBANK A ARE ALSO DISABLED.

CFG JUMPER (J83) MUST BE ON BOTH PINS.

SAFETY SIGN

The safety sign enclosed with your Owner's Manual should be permanently installed where visible to all users of the spa. This sign is adhesive backed and includes four screws for mounting the sign on rough surfaces. It is very important that you, as a spa owner, review the important safety instructions and warnings before you operate your spa. It is equally important that you instruct all users, even occasional ones, as to the warnings associated with spa use.

You may obtain additional signs by contacting :

USA: MAAX Spas Industries Corp.
Customer Service
25605 South Arizona Avenue
Chandler, Arizona 85248
www.maaxspas.com

LIMITED WARRANTY SUMMARY

Please refer to the Warranty Card included with your product for complete warranty information. In order to receive prompt warranty service, you must return your warranty card, completed with model and serial number, to your dealer immediately upon completion of the spa installation. MAAX Spas Industries Corp. provides a limited warranty to our customers. It applies to the spa structure, surface, plumbing, pumps, heater, blower, and controls. The limited warranty does not cover damage resulting from improper maintenance, improper installation, misuse, abuse, neglect, accident, fire, normal wear and tear, or improper water maintenance. Unauthorized modifications of the spa may void the warranty. Replacement cost associated with transportation, removal and reinstallation are the sole responsibility of the spa owner. This manual refers to only year 2010 Vita model spas. MAAX Spas Industries Corp., reserves the right to make changes in design or material of its products at any time without incurring liability. This limited warranty applies to the first retail purchaser and terminates upon any transfer of ownership.

COPYRIGHTS AND TRADEMARKS

©Copyright 2010 MAAX Spas Industries Corp.. All rights reserved. No parts of this publication may be reproduced, stored in a retrieval system, or transmitted, in any form or by any means (electronic, mechanical, photocopying, recording or otherwise), without prior written permission. Vita Spa™, Powerworks™, are registered trademarks of MAAX® Spas.

Disclaimer:

The information in this manual is accurate to the best of MAAX Spas Industries Corporations' knowledge. However, MAAX Spas Industries Corporation assumes no responsibility for errors or omissions. Nor is any liability assumed for damages resulting from use of the information contained herein. Specifications subject to change without notice. Spas shown at percentage of actual size.

Congratulations on your purchase of an Vita Spa from MAAX® Spas. Your Owner's Manual provides installation, operation and maintenance instructions. Please review it and keep it for future references.

Save These Instructions Owner's Record Information

Date Purchases : _____

Purchased From : _____

Phone Number : _____

Installed By : _____

Serial Number : _____ Model : _____

